



SP1/ SP2 Support Pole

- Detachable Design
- High-Strength Aluminum Construction
- Equipped a 5/8"-11 Adapter and one Extra 1/4"-20 Transit Adapter
- Includes Carry Bag



Model No.:

SP136: Support Pole 1 Series (w/o Tripod) 3.6m (Regular Height)
 SP236: Support Pole 2 Series (with Tripod) 3.6m (Regular Height)
 SP130/ SP140/ SP142/ SP148: Support Pole 3.0/ 4.0/ 4.2/ 4.8m for Option (w/o Tripod)
 SP230/ SP240/ SP242/ SP248: Support Pole 3.0/ 4.0/ 4.2/ 4.8m for Option (with Tripod)



SP3 Lightweight Support Pole

- Aluminum Construction for Strength and Lightweight
- Equipped with 1/4"-20 Adapter and one Extra 5/8"-11 Transit Adapter
- Quick Extension with Compression Lock
- Includes Carry Bag

Model No.:

SP330: Support Pole 3 Series, 3.0m Height
 SP336/ SP340/ SP342/ SP348: Support Pole, 3 Series, 3.6/ 4.0/ 4.2/ 4.8m Height For Option

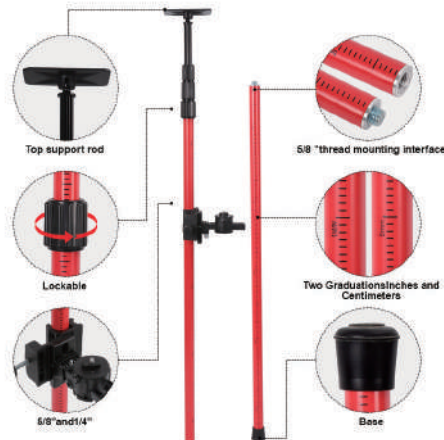

LR240/350 Laser Grade Rod

- Two-Colored Aluminum Rod for Precise Elevation Measurement
- Graduation in mm/ in, Height 2.4m(7.87ft), 3.5m(11.48ft) for Option
- Includes Circular Bubble and Carry Bag

Model Options:

LR240/350-2T: 2.40m/ 3.50m, 2 Sections, Twist Lock, Screen Printing
 LR240/350-2Q: 2.40m/ 3.50m, 2 Sections, Quick Lock, Screen Printing
 LR240/350-2TP: 2.40m/ 3.50m, 2 Sections, Twist Lock, Penetration Screen Printing
 LR240/350-2QP: 2.40m/ 3.50m, 2 Sections, Quick Lock, Penetration Screen Printing



LR240-2T

LR240-2Q

Geological Hammer

GH-A300/A600 Geological Hammer
 With Pointed Tip & Shock Reduction Grip

Model No.:

GH-A300: 13oz (300g)
 GH-A600: 22oz (600g)



GH-A300

GH-B300/B600 Geological Hammer
 With Point Flat Head & Shock Reduction Grip

Model No.:

GH-B300: 12oz (300g)
 GH-B600: 22oz (600g)



GH-B300

Measuring Tape



X2020



G2020



N2020

X2020 Fiberglass Long Measuring Tape

Model No.:

X2020-30M: Length 30m
 X2020-50M: Length 50m

G2020 Steel Long Measuring Tape

Model No.:

G2020-30M: Length 30m
 G2020-50M: Length 50m

N2020 Nylon Coating Steel Long Measuring Tape

Model No.:

N2020-30M: Length 30m
 N2020-50M: Length 50m



SW-213A/213B Surveying Wheel

Maximum Measurement Range: 0-9999.9m/ft
 Accuracy: $\pm 0.5\%$
 Minimum Display Value: 0.1m/ 0.1ft
 Product Material: PC+ABS+POM
 Folding Length: 440mm
 Aluminum Alloy Rod Diameter: 16/19/22mm

Model No.:

SW-213A: Wheel Diameter 142mm
 SW-213B: Wheel Diameter 159mm

SW-215 Surveying Wheel

Maximum Measurement Range: 0-9999.9m/ft
 Wheel Diameter: 159mm
 Accuracy: $\pm 0.5\%$
 Minimum Display Value: 0.1m/0.1ft
 Product Material: PC+ABS+POM
 Folding Length: 440mm
 Aluminum Alloy Rod Diameter: 16/19/22mm

SW-214B/214D Surveying Wheel

Maximum Measurement Range: 0-9999.9m/ft
 Wheel Diameter: 318mm
 Accuracy: $\pm 0.5\%$
 Minimum Display Value: 0.1m/ 0.1ft
 Product Material: PC+ABS+POM
 Folding Length: 500mm
 Stainless Steel Rod Diameter: 22mm



SW-216A Surveying Wheel with Light

Maximum Measurement Range: 0-9999.9m/ft
 Wheel Diameter: 318mm
 Accuracy: $\pm 0.5\%$
 Minimum Display Value: 0.1m/ 0.1ft
 Product Material: PC+ABS+POM
 Folding Length: 500mm
 Stainless Steel Rod Diameter: 22mm

SW-217B Surveying Wheel

Maximum Measurement Range: 0-9999.9m/ft
 Wheel Diameter: 318mm
 Accuracy: $\pm 0.5\%$
 Minimum Display Value: 0.1m/ 0.1ft
 Product Material: PC+ABS+POM
 Folding Length: 500mm
 Iron Rod Diameter: 22mm

SW-318/328 Surveying Wheel with Brke

Maximum Measurement Range: 0-9999.9m/ft
 Accuracy: $\pm 0.5\%$
 Minimum Display Value: 0.1m/ 0.1ft
 Product Material: PC+ABS+POM
 Folding length: 440mm
 Stainless Steel Rod Diameter: 25mm

Model No.:

SW-318: Wheel Diameter 159mm
 SW-328: Wheel Diameter 318mm





SW-410

SW-400

SW-410 Surveying Wheel with Brake

Maximum Measurement Range: 0-9999.9m/ft
 Wheel Diameter: 318mm
 Accuracy: $\pm 0.5\%$
 Minimum Display Value: 0.1m/ 0.1ft
 Product Material: PC+Nylon
 Folding Length: 500mm
 Stainless Steel Rod Diameter: 43.6mm

SW-400 Surveying Wheel with Brake

Maximum Measurement Range: 0-9999.9m
 Wheel Diameter: 318mm
 Accuracy: $\pm 0.5\%$
 Minimum Display Value: 0.1m
 Product Material: PC+ABS+POM
 Folding Length: 500mm
 Stainless Steel Rod Diameter: 26mm

SW-100/101 Metal Surveying Wheel

Maximum Measurement Range: 0-9999.9m
 Wheel Diameter: 318mm Accuracy: $\pm 0.5\%$
 Minimum Display Value: 0.1m
 Folding Length: 540mm
 Product Material: Pure Steel Wheel+ Stainless Steel Handle+PVC

Model No.:

SW100: Basic Type
 SW101: With Sound Device(Make a Sound Every Meter)

SW-330/331 Digital Surveying Wheel

Maximum Measurement Range: 0-9999.9m/ft
 (Metric and English Conversion)
 Wheel Diameter: 160mm Accuracy: $\pm 0.5\%$
 Minimum Display Value: 0.1m/ 0.1ft
 Power Supply: 3V (2 x AA Batteries)
 Product Material: PC+ABS+POM

Model No.:

SW-330: Wheel Diameter 160mm
 SW-331: Wheel Diameter 318mm



SW-100

SW-330

SW-331



SW-334

SW-335

SW-334/335 Digital Surveying Wheel

Maximum Measurement Range: 0-9999.9m/ft
 (Metric and English Conversion)
 Accuracy: $\pm 0.5\%$
 Minimum Display Value: 0.01m/0.01in
 Power Supply: 3V (2 x AA Batteries)
 Product Material: PC+ Nylon
 Folding Length: 540mm
 Aluminum Alloy Rod Diameter: 23/26.5/30mm

Model No.:

SW-334: Wheel Diameter 160mm, Folding Length 540mm
 SW-335: Wheel Diameter 318mm, Folding Length 610mm

SW-236/237 Digital Surveying Wheel

(Metric system) Length measuring range: 0.05 - 99999.9m.
 (Metric system) Mu measuring range: 0.000003 - 99999.9mu.
 (Feet system) Length measuring range: 0.016 - 99999.9ft.
 (Acre system) Mu measuring range: 0.00001 - 99999.9acre.
 Accuracy: $\pm 0.5\%$
 Power Supply: 3V (2x AA Batteries)
 Material of pole: Aluminum + ABS.
 Minimum Display Value: 0.05m/0.05ft

Model No.:

SW-236: Wheel Diameter 159mm
 SW-237: Wheel Diameter 318mm



SW-236

SW-237

Adapter & Tribrach

FG01X GPS Adapter 5/8"-11 Thread	FG01S Removable Rotating Adapter 5/8"-11 Thread	FG01TP Rotating Adapter 5/8"-11 Thread	FG01HA 3D Scanner Rotating Adapter 3/8"-16 Thread	FG01H Removable Rotating Adapter 5/8"-11 Thread
FG01T Removable Rotating Adapter 5/8"-11 Thread	FG01L GPS Adapter 5/8"-11 Thread	FG01N GPS Adapter 5/8"-11 Thread	FDC01 TP Adapter w/o Optical Plummet	FDC01D TP Adapter With Optical Plummet
FDC01G TP GPS Adapter w/o Optical Plummet	FDC01DG TP GPS Adapter With Optical Plummet	FDJ01 TP Tribrach w/o Optical Plummet	FDJ01D TP Tribrach With Optical Plummet	FDJ01L Tribrach With Laser Plummet
GAD103 Swiss Mini Prism Adapter	GAD105 Swiss Mini Prism Adapter	GAD31 Swiss Screw-to-Stub Adapter	GRT247 Swiss Carrier 5/8"-11 Thread	GRT10 Swiss Carrier With Stub
GRT144 Swiss Carrier With Stub	GRT146 Swiss Carrier 5/8"-11 Thread	FDC01M Swiss Carrier With Optical Plummet	FDC01MG Swiss Carrier With Optical Plummet 5/8"-11 Thread	GZR103 Swiss Precision Carrier With Optical Plummet

GZR2 Swiss Precision Carrier w/o Optical Plummet	GZR3 Swiss Precision Carrier With Optical Plummet	GDF21 Swiss Tribrach w/o Optical Plummet	GDF22 Swiss Tribrach With Optical Plummet	GDF121 Swiss Precision Tribrach w/o Optical Plummet
GDF122 Swiss Precision Tribrach With Optical Plummet	GDF311 Swiss Precision Tribrach w/o Optical Plummet	GDF312 Swiss Precision Tribrach With Optical Plummet	GDF321 Swiss Precision Tribrach w/o Optical Plummet	GDF322 Swiss Precision Tribrach With Optical Plummet
TRA01D TR Precision Adapter With Optical Plummet	TRT01 TR Precision Tribrach w/o Optical Plummet	TRT01D TR Precision Tribrach With Optical Plummet	TPT01 TP Precision Tribrach w/o Optical Plummet	TPT01D TP Precision Tribrach With Optical Plummet
MPA01 Mini Prism Adapter Swiss and 5/8"-11 Thread	MPA02 Mini Prism Adapter Swiss and 3/8"-19 Thread	MPA03 Mini Prism Adapter Swiss and M8 Thread	MPA04 Mini Prism Adapter Swiss Thread	AD-L01 Stainless Steel Adapter Swiss and M10 Thread
AD-L02 Stainless Steel Adapter Swiss and 1/4"-20 Thread	AD-L03 Stainless Steel Adapter Swiss and M8 Thread	AD-L04 Stainless Steel Adapter Swiss and 3/8"-24 Thread	AD-L05 Stainless Steel Adapter Swiss and 5/8"-11 Thread	AD-L06 Stainless Steel Adapter Swiss and M8 Thread

Adapter & Tribrach

				
AD-L07 Copper Adapter Swiss and M8 Thread	AD-L08 Aluminum Adapter Swiss and 5/8"-11 Thread	AD-L09 Stainless Steel Adapter Swiss and 5/8"-11 Thread	AD-L10 Stainless Steel Adapter Swiss and M8 Thread	AD-S01 Aluminum Adapter Dual 5/8"-11 Thread
				
AD-S02 Stainless Steel Adapter 5/8"-11 and M8	AD-S03 Stainless Steel Adapter 3/8"-19 and M8 Thread	AD-S04 Stainless Steel Adapter 5/8"-11 and M8 Thread	AD-S05 Copper Adapter 5/8"-11 and M8 Thread	BC-01 Galvanized Steel Beam Clamp M8 Thread, Width 0-23mm
				
WA-40 Wall Anchor M8 Thread H40mm	CB-A22250 Galvanized Steel Convergence Bolt Swiss Plug OD22mm, H250mm	CB-B22250 Galvanized Steel Convergence Bolt M8 Thread, OD22mm, H250mm	CB-C22250 Galvanized Steel Convergence Bolt 5/8"-11 Thread, OD22mm, H250mm	CB-D22250 Galvanized Steel Convergence Bolt 3/8"-19 Thread, OD22mm, H250mm
				
AD-A30 Aluminum Adapter Dual 5/8"-11 Thread OD22mm, H30mm	AD-A35 Aluminum Adapter Dual 5/8"-11 Thread OD22mm, H35mm	AD-A45 Aluminum Adapter Dual 5/8"-11 Thread OD22mm, H45mm	AD-A50 Aluminum Adapter Dual 5/8"-11 Thread OD22mm, H50mm	AD-A100 Aluminum Adapter Dual 5/8"-11 Thread OD22mm, H100mm
				
AD-B15 Aluminum Adapter Dual 5/8"-11 Thread OD25mm, H15mm	AD-B35 Aluminum Adapter Dual 5/8"-11 Thread OD25mm, H35mm	AD-B50 Aluminum Adapter Dual 5/8"-11 Thread OD25mm, H50mm	AD-B80 Aluminum Adapter Dual 5/8"-11 Thread OD25mm, H80mm	AD-B100 Aluminum Adapter Dual 5/8"-11 Thread OD25mm, H100mm

Adapter & Tribrach

			 <p>AD-E02 AD-E03</p>	 <p>AD-E04 AD-E05</p>
<p>AD-C50 Aluminum Adapter M8 and 5/8"-11 Thread OD32mm, H50mm</p>	<p>AD-D64 Aluminum Adapter Swiss and 5/8"-11 Thread OD25mm, Add H50 + 14mm</p>	<p>AD-E01 Aluminum Adapter 1/4"-20 and 5/8"-11 Thread OD25mm, H18.5mm</p>	<p>AD-E02/03 Adapter Dual 5/8"-11 Thread AD-E02: Aluminum, H20mm AD-E03: Stainless Steel, H22mm</p>	<p>AD-E04/05 Aluminum GPS Adapter Dual 5/8"-11 Thread OD25mm, H30/24mm</p>
	 <p>QRA01A QRA01B</p>			
<p>AD-F01 Aluminum Adapter Dual Female 5/8"-11 Thread</p>	<p>QRA01 Quick Release Aluminum Adapter Add H24/ 76mm</p>	<p>QRA02 Quick Release Adapter H40mm</p>	<p>QRA03 Quick Release Aluminum Adapter H36mm</p>	<p>QRA04 Anti-Rotation Quick Release Adapter H60mm</p>
				
<p>MPT01 Mini Prism Rotating Tribrach M6 Thread</p>	<p>MPT02 Mini Prism Rotating Tribrach 1/4"-20 Thread</p>	<p>MPT03 Mini Prism Rotating Tribrach 5/8"-11 Thread</p>	<p>MPT04 Mini Prism Tribrach 5/8"-11 Thread</p>	<p>MPT05 Mini Prism Tribrach For Prism with OD9mm Hole</p>
				
<p>PPA01 Aluminum Prism Pole Adapter 5/8"-11 and M12 Thread</p>	<p>PPA02 Copper Prism Pole Adapter 5/8"-11 and M12 Thread</p>	<p>PPA03 Aluminum Prism Pole Adapter M12 Thread</p>	<p>PPA04 Aluminum Prism Pole Adapter Swiss and M12 Thread</p>	<p>PPA05 Adjustable Prism Pole Adapter 5/8"-11 and M12 Thread</p>
				
<p>LLA01 Laser Level Adapter 1/4"-20 to 5/8"-11</p>	<p>LLA02 Laser Level Adapter 5/8"-11 to 1/4"-20</p>	<p>LLA03 Laser Level Adapter 5/8"-11 to 1/4"-20</p>	<p>LLA04 Laser Level Adapter 5/8"-11 to 5/8"-11</p>	<p>LLA05 Laser Level Adapter 5/8"-11 to 1/4"-20</p>

RT Reflective Target

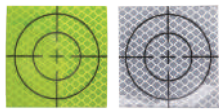

- 3M Material, Various Color for Option
- Magnetic Sticker (M) for Option
- Size 10/20/30/40/50/60/80/100/150mm for Option



Magnetic Sticker

Model No. Sample:

- RT10: Reflective Sheet 10 x 10mm
- RT10M: Reflective Sheet 10 x 10mm, with Magnetic Sticker

RT101 Reflective Target



- With 30 x 30mm Reflective Adhesive Sheet
- 3M Material
- High-Strength Nylon Mainbody
- Size: 100 x 35 x 30mm Height

Model No. :

- RT101S: Reflective Target, Single Side
- RT101D: Reflective Target, Double Side

RT102/103 Reflective Target



- Reflective Adhesive Sheet, 3M Material
- RT102: OD50mm; RT103: OD60mm
- High-Strength Nylon Mainbody
- Feature with Adapter

Model No. :

- RT102-A01: With Adapter, Female Thread 5/8"
- RT102-A02: With Adapter, Female Thread 3/8"
- RT102-A03: With Adapter, Female Thread M8
- RT103-A01: With Adapter, Female Thread 5/8"
- RT103-A02: With Adapter, Female Thread 3/8"
- RT103-A03: With Adapter, Female Thread M8

RT104/ RT105 Reflective Target



- RT104:**
- With 60 x 60mm Reflective Adhesive Sheet
- 3M Material
- Die-Cast Aluminum Mainbody
- With 5/8"-11 Aluminum Adapter

RT105:

- Reflective Adhesive Sheet Diameter: 60mm
- 3M Material
- High-Strength Nylon Mainboard
- With Quick Release System

RT106 Reflective Target



- With 40 x 40mm Reflective Adhesive Sheet
- 3M Material
- Aluminum Mainbody
- M8 Thread

RT107 Switchable Magnetic Reflective Target



- With 50 x 50mm Reflective Adhesive Sheet
- Center Distance: 150mm
- With On/Off Magnetic Base
- Designed to Hold on to Pipes, Flip the Switch to Release Its Hold on Metal Surfaces

RT108 Magnetic Rotary Reflective Target



- 360 Degree Universal Rotating Magnetic Target
- With Reflective Adhesive Sheet, 3M Material
- Aluminum Mainbody
- Magnetic Base, Directly Affixed to Measuring Points

Model No. :

- RT108-50: With Reflective Sheet 50 x 50mm
- RT108-90: With Reflective Sheet 90 x 90mm

RT109 Rotary Reflective Target



- With 30 x 30mm Reflective Adhesive Sheet
- 3M Material
- Plastic Mainbody
- Height of Tilting Axis: 30mm

RT110 Reflective Target with Pole



- Prism Diameter: 60mm
- Prism Offset: 0mm
- Machined Anodized Aluminum Body
- Two Back-to-back Prism
- Allows the Target to Tilt 360 Degree
- Aluminum Pin Pole, 1/4"-20 Thread, OD12mm
- 300mm x 4 Sections, Extend to 1.2m (AP123004)
- Standard Packed with Soft Bag

RT111 Magnetic Reflective Tape Target

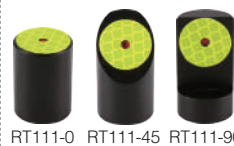

- For Swiss system
- OD: 20mm

Model No.:

- RT111-0: Horizontal Magnetic Reflective Tape Target
- RT111-45: 45 Degree Magnetic Reflective Tape Target
- RT111-90: Vertical Magnetic Reflective Tape Target

MP113 Mini Prism



- Prism Diameter: 25.4mm
- Copper Coated, Hermetically Sealed
- Prism has Ability to Swivel 360°
- Light-weight, Wide Aluminum Plate Suits Epoxy Bonding
- Option to Remove Prism if flange is Damaged During Removal

MP114 Mini Prism



- Prism Diameter: 25.4mm
- Copper Coated

MP090 Mini Prism



- Copper or Silver Coating
- A Rotatable and Tilttable Prism for Ground Monitoring Tasks
- With Side Lock
- Aluminium Housing
- Base Plate 35 x 38mm
- Diameter of Fixing Holes 3.5mm
- Distance of Fixing Holes Center 10mm

Model No.:

MP090A: Diameter: 12.7mm
MP090B: Diameter: 25.4mm

MP091 Mini Prism



- Copper or Silver Coating
- A Rotatable and Tilttable Prism for Ground Monitoring Tasks
- Aluminium Housing with Snow and Rain Cover
- Base Plate 40 x 40mm
- Diameter of Fixing Holes 3mm

Model No.:

MP091A: Diameter 25.4mm
MP091B: Diameter 35.0mm

MP092 Mini Prism



- Adjustable a Direction of Prism in X and Y Axis Easily
- Water Resistance Structure

Model No.:

MP092A: Prism Diameter 25.4mm
MP092B: Prism Diameter 38.1mm

MP092A

MP092B

MP093 Mini Prism



- Prism Diameter: 64mm
- Copper Coating
- Prism Height: 48mm

SE6603-05 SE Monitoring Prism



- Prism Diameter: 62mm
- Mounting Arm Tilt up to 240°, Prism Mount 360° Rotation
- Mounting Holes OD 0.328" (8.3mm)
- Prism Mounting Holes 1.75" (44.4mm) Apart
- Included Rain Hood

MP104 Mini Prism



- Prism Diameter: 25.4mm
- Copper or Silver Coating
- Prism Offset: 17.5mm
- Feature with Adapter

Model No.:

MP104-A01: Prism With Adapter Thread 5/8"
MP104-A02: Prism With Adapter Thread 3/8"
MP104-A03: Prism With Adapter Thread M8

MP105 Mini Prism



MP105

- Copper or Silver Coating
- Feature with Adapter
- MP105A: Diameter 25.4mm
- MP105B: Diameter 38.1mm

Model No.:

MP105A-A01: Prism With Adapter Thread 5/8"
MP105A-A02: Prism With Adapter Thread 3/8"
MP105A-A03: Prism With Adapter Thread M8

MP105B-A01: Prism With Adapter Thread 5/8"
MP105B-A02: Prism With Adapter Thread 3/8"
MP105B-A03: Prism With Adapter Thread M8

MP095 Mini Prism



- Prism Diameter: 12.7mm
- Copper or Silver Coating
- Base Diameter: 80mm
- Base Material: Nylon

Model No.:

MP095SM: Single Mini Prism, Glass in the Middle
MP095SS: Single Mini Prism, Glass in the Side
MP095D: Double Mini Prism

MP109 Angled Mini Prism

MP109S



- Prism Diameter: 12.7mm
- Copper or Silver Coating
- Size: 100 x 35 x 30mm Height

Model No.:

MP109S: Single Mini Prism
MP109D: Double Mini Prism

MP111 Plastic Road Prism



- Prism Diameter: 12.7mm
- Copper or Silver Coating
- Plastic Hoder OD: 145mm
- Height of Pavement: 20mm
- Vertical Inclination of 10 Degree

MP112 Metal Road Prism



- Prism Diameter: 17.5mm
- Prism Height: 13.5mm
- Die-cast Aluminum Body
- Vertical Inclination of 20 Degree
- Size: 100 x 100 x 23mm

RAP001 Right Angle Prism



- Measures 90 Degree Angles
- Plumb Bob Cord Slot
- Plastic Construction
- Leather Belt Loop Case

RAP002 Double Right Angle Prism



- Measures 90 and 180 Degree Angles
- 2 Prisms for Left and Right Sight
- Large Center Lens
- Plumb Bob Cord Slot
- Metal Construction
- Leather Belt Loop Case

RAP003 Double Right Angle Prism



- Measures 90 and 180 Degree Angles
- 2 Prisms for Left and Right Sight
- Large Center Lens
- Plumb Bob Cord Slot
- Metal Construction
- Leather Belt Loop Case

BP001 Ball Prism with Magnetic Base



- Copper or Silver Coating
- Magnetic Base Diameter: 35mm

Model No.:

• BP001A: Prism OD17.8mm, Ball OD 30.0mm
• BP001B: Prism OD25.4mm, Ball OD 38.1mm

BP002 Ball Prism with Magnetic Base



- Copper or Silver Coating
- Magnetic Base Diameter: 40mm

Model No.:

• BP002A: Prism OD17.8mm, Ball OD 30.0mm
• BP002B: Prism OD 25.4mm, Ball OD38.1mm
• BP002C: Prism OD 25.4mm, Ball OD45.0mm

BP003 Ball Prism



- Prism Diameter: 17.8mm
- Ball Diameter: 30mm
- Magnetic Base Diameter: 35mm

BP004 Ball Prism



BP004A

BP004B

- Prism Diameter: 64mm
- Prism Offset: 0mm
- BP004A: With Lock for Swiss Quick Release Adapter
- BP004B: With Quick Release Lock for Swiss Quick Release Adapter

MP110S Mini Prism



- Mini Corner Cube Prism
- Copper or Silver Coating
- Prism Diameter: 12.7mm
- Operates on Two Axis
- Machined Anodized Aluminum Body

MP110T TR Mini Prism



- TR System L Bar Monitoring Prism
- Copper or Silver Coating
- Prism Diameter: 25.4mm
- Machined Anodized Aluminum Body

MP110B Mini Prism



- L Bar Monitoring Prism
- Prism Diameter: 38.1mm
- Copper or Silver Coating
- Machined Anodized Aluminum Body

MP110R Mini Prism



- L Bar Monitoring Prism
- Copper or Silver Coating
- Prism Diameter: 25.4mm
- Machined Anodized Aluminum Body
- Removable Back Cover



MP110D Double Side Mini Prism



- Double-Side L Bar Monitoring Prism
- Copper or Silver Coating
- Prism Diameter: 25.4mm
- Machined Anodized Aluminum Body

MP110 Mini Prism



- L Bar Monitoring Prism
- Copper or Silver Coating
- Prism Diameter: 25.4mm
- Die-cast Aluminum Body



MP110H Mini Prism



- L Bar Monitoring Prism
- Copper or Silver Coating
- Prism Diameter: 25.4mm
- Machined Anodized Aluminum Body, High Quality Style (H)

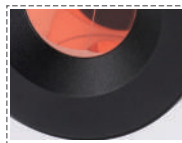

MP110W/ MP110HW Mini Prism



- L Bar Monitoring Prism
- Copper or Silver Coating
- Prism Diameter: 25.4mm
- With Waterproof Ring (W)

Model No.:

MP110W: Die-cast Aluminum Body
MP110HW: Machined Anodized Aluminum Body, High Quality Style (H)



MP110V/ MP110HV Mini Prism



- L Bar Monitoring Prism
- Copper or Silver Coating
- Prism Diameter: 25.4mm
- Includes Visibility Ring (V)

Model No.:

MP110V: Die-cast Aluminum Body
MP110HV: Machined Anodized Aluminum Body, High Quality Style (H)

MP110C/ MP110HC Mini Prism



- L Bar Monitoring Prism
- Copper or Silver Coating
- Prism Diameter: 25.4mm
- Includes Waterproof Cap (C)

Model No.:

MP110C: Die-cast Aluminum Body
MP110HC: Machined Anodized Aluminum Body, High Quality Style (H)

MP108 Mini Prism



- Prism Accuracy 360° Rotary: ±0.2mm
- Copper or Silver Coating

Model No.:
 MP108A: Prism Diameter: 25.4mm
 MP108B: Prism Diameter: 38.1mm

MP108A MP108B

MP061A Mini Prism



- Prism Diameter: 25.4mm
- Copper or Silver Coating
- Prism Offset: 0/-30mm
- With 5/8"-11 Female Adapter
- With Nonferrous Anodized Aluminum Body

Model No.:
 MP061AM: Middle Vial
 MP061AS: Side Vial

For Option :
 MPT03 or MPT04 Mini Prism Tribach

MP061B Mini Prism



- Prism Diameter: 25.4mm
- Copper or Silver Coating
- Prism Offset: 0/-30mm
- With Nonferrous Anodized Aluminum Body

Model No.:
 MP061BM: Middle Vial
 MP061BS: Side Vial

For Option :
 MPT03 or MPT04 Mini Prism Tribach

MP062 Mini Prism



- Prism Diameter: 25.4mm
- Copper or Silver Coating
- Offset: 0/-30mm
- With 5/8"-11 Female Adapter
- With Nonferrous Anodized Aluminum Body
- Equipped with Side Bubble Level

For Option :
 MPT03 or MPT04 Mini Prism Tribach

GMP101 Swiss Mini Prism



- Prism Diameter: 25.4mm
- Copper or Silver Coating
- Offset: +17.5mm
- With Die Casting Aluminum Body

TRM01 TR Monitoring Prism



- Prism Diameter: 62mm
- Prism Offset: -40mm
- With GNSS Antenna Mount
- Combine GNSS Antenna with a Prism for Integrated Monitoring

TRM02 TR Large Monitoring Prism



- Prism Diameter: 62mm
- Prism offset: -40mm
- Ability to Pivot in Two Axes, Stainless Steel Locking
- M20 Screw-in Type Prism Canister with Stainless Steel Locking
- Flat Bottom of the L-Bracket is a Large 2.3 x 3.4" with Five Holes
- 3/8-in (9.5mm) Center Pivot Hole, with Four OD 11/64" (4.5mm) Screw Holes
- Rain Hood Keep Prism Clean to Ensure Long-term Measuring

GPR112S Swiss Monitoring Prism Set



- Prism Diameter: 62mm
- Prism offset: -40mm
- Large Diameter Monitoring Prism Set for Long Range Measurements
- For Installation on M8 or 5/8" Threaded Bolts
- Prism can be Adjusted and Fixed on Both Axes
- Built-in Filter Prevents Condensation on the Backside of the Prism
- Rain/snow Cover Available

Model No.:
 GPR122S: Monitoring Prism Set
 GPR112: Monitoring Prism with Shell Only
 GDZ112: Rain Shelter GHT112: Mounting Set

SP060 Sliding Mini Prism with Pole



- Prism Diameter: 25.4mm
- Copper or Silver-Coating
- Offset: 0mm
- Machined Anodized Aluminum Body
- Side Cones as Double Lock
- Featured with Hook, Corner Adapter
- Steel Pin Pole, M6 Thread, OD9mm
- 600mm x 3 Sections, Extend to 1.8m(SP096003)
- Standard Packed with Soft Bag

For Option :
 MPT05 Mini Prism Tribach
 Aluminum Tube for Pin Pole

SP061 Mini Prism with Pole



- Prism Diameter: 25.4mm
- Copper or Silver-Coating
- Prism Offset: 0/-30mm
- With Nonferrous Anodized Aluminum Body
- Featured with Plumb Bob Bracket and S-hook
- With a Point for Stake-out Work
- Aluminum Pin Pole, 1/4"-20 Thread, OD12mm
- 300mm x 4 Sections, Extend to 1.2m(AP123004)
- Standard Packed with Soft Bagt

Model No.:
 SP061M: Middle Bubble SP061S: Side Bubble

For Option :
 MPT03/04 Mini Prism Tribach
 Aluminum Tube for Pin Pole

SP063 Mini Prism with Pole

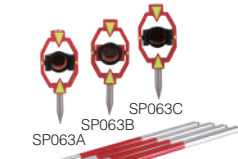

- Prism Diameter: 25.4mm
- Material: High-strength Nylon
- Aluminum Pole, 1/4"-20 Thread, OD12mm
- 300mm x 4 Sections, Extend to 1.2m (AP123004)
- Standard Packed with Soft Bag

Model No.:
 SP063A: Offset 0mm, Copper-Coating, Swiss System
 SP063B: Offset 17.5mm, Copper-Coating, Swiss System
 SP063C: Offset 0/-30mm, Copper-Coating, Non-Swiss

For Option :
 MPT02 Mini Prism Tribrach
 Aluminum Tube for Pin Pole
 with MPT02

GMP111 Mini Prism with Pole

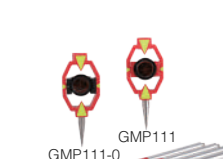

- Prism Diameter: 25.4mm
- Material: High-strength Nylon
- Aluminum Pole, 1/4"-20 Thread, OD12mm
- 300mm x 4 Sections, Extend to 1.2m (AP123004)
- Standard Packed with Carton

Model No.:
 GMP111-0: Offset 0mm, Copper-Coating, Swiss System
 GMP111: Offset 17.5mm, Copper-Coating, Swiss System

SP066 Mini Prism with Pole



- Prism Diameter: 38.1mm
- Silver-Coating
- Prism Offset: 0/30mm
- With Corner Adapter for Corner Use
- Adapter with Male 1/4"-20 and Female 5/8"-11 Thread for Prism Pole Use
- With Adapter for Handle Using
- Aluminum Pin Pole, 1/4"-20 Thread, OD12mm
- 300mm x 5 Sections, Extend to 1.5m (AP123005)
- Standard Packed with Soft Bag

For Option :
 MPT03/04 Mini Prism Tribrach
 Aluminum Tube for Pin Pole

SP069 Mini Prism with Pole



- Prism Diameter: 38.1mm
- Silver-Coating
- Prism Offset: 0/30mm
- With Adapter for Corner Use and Handle Using
- Adapter with Male M6 and Female 5/8"-11 Thread
- Stainless Steel Pin Pole, M6 Thread, OD9mm
- Standard Packed with Soft Bag

Model No. :
 SP069A: Mini Prism with Pole, 500mm x 3 Sections, Extend to 1.5m (SP095003)
 SP069B: Mini Prism with Pole, 300mm x 5 Sections, Extend to 1.5m (SP093005)

For Option :
 MPT03/04 Mini Prism Tribrach
 Aluminum Tube for Pin Pole
 with MPT01

SP067 Sliding Prim with Pole



- Prism Diameter: 25.4mm
- Silver-Coating
- Prism Offset: 0/-30mm
- With Nonferrous Anodized Aluminum Body
- Features a Rear Locking System to Adjust Height
- The Vertical Angle Site Cones as Double Locks, one for the Height and the Other for the Tilt
- Bubble Level on Top and Bottom of the Prism Holder
- Include a Adapter 5/8"-11 Thread, Fit for Prism Pole and Tribrach
- Aluminum Rod, 1/4"-20 Thread, OD12mm
- 300mm x 4, Extend to 1.2m
- Standard Packed with Soft Bag

SP068 Sliding Prim with Pole



- Prism Diameter: 25.4mm
- Copper-Coating
- Prism Offset: 0/-30mm
- With Nonferrous Anodized Aluminum Body
- Aluminum Rod, 1/4"-20 Thread, OD12mm
- 305mm x 3 and 300mm x 1, Extend to 1.22m
- Equipped with Side Cones as Double Lock
- Include a Brass Adapter with 5/8"-11 Thread, Fit for Prism Pole and Tribrach
- With Soft Bag and Inner Box

SP065 Sliding Prism with Pole



- Prism Diameter: 38.1mm
- Silver-Coating
- Prism Offset: 0mm
- With Corner Adapter for Corner Use
- Stainless Steel Pin Pole, M6 Thread, OD9mm
- Prism with Screw Lock(S)
- Prism with Screw Lock and Quick Release Lock(D)

Model No.:
 SP065SA/DA: Mini Prism with Pole, 500mm x 3 Sections, Extend to 1.5m (SP095003)
 SP065SB/DB: Mini Prism with Pole, 300mm x 5 Sections, Extend to 1.5m (SP093005)

For Option :
 MPT05 Mini Prism Tribrach
 Aluminum Tube for Pin Pole
 with MPT05

MG1000SPT TP sliding Prism with Pole



- Prism Diameter: 25.4mm
- Silver-Coating
- Can be used as Corner Prism
- Quick Release Button for Sliding Easily
- Prism Part Can Be Moved 180 Degree
- Stainless Steel Pin Pole, M6 Thread, OD9mm
- Standard Packed with Soft Bag

Model No. :
 MG1000SPTA: Mini Prism with Pole, 500mm x 3 Sections, Extend to 1.5m (SP095003)
 MG1000SPTB: Mini Prism with Pole, 300mm x 5 Sections, Extend to 1.5m (SP093005)

M1500 TP Sliding Prism with Pole



- Prism Diameter: 38.1mm
- Silver-Coating
- Prism Offset: 0mm
- With Corner Adapter for Corner Use
- Stainless Steel Pin Pole, M6 Thread, OD9mm
- Standard Packed with Soft Bag
- Prism with Pole, Screw Lock (M1500MP)
- Prism with Pole, Dual Lock (M1500GP)

Model No.:
 M1500MPA/GPA: Mini Prism with Pole, 500mm x 3 Sections, Extend to 1.5m (SP095003)
 M1500MPB/GPB: Mini Prism with Pole, 300mm x 5 Sections, Extend to 1.5m (SP093005)

MG1500SL TP Mini Prism with Pole



- Prism Diameter: 38.1mm
- Silver-Coating
- Prism Offset: 0/-30mm
- With Corner Adapter for Corner Use
- Adapter with Male M6 and Female 5/8"-11 Thread for Prism Pole Use
- With Adapter for Handle Using
- Stainless Steel Pin Pole, M6 Thread, OD9mm
- Standard Packed with Soft Bag

Model No. :
 MG1500SLA: Mini Prism with Pole, 500mm x 3 Sections, Extend to 1.5m (SP095003)
 MG1500SLB: Mini Prism with Pole, 300mm x 5 Sections, Extend to 1.5m (SP093005)

GRZ4 360° Prism



GRZ4-N



GRZ4-M QRA01A

- Prism Assembly Consist of Six Mini Prism Glued Together
- Prism Constant: +23.1mm (Swiss Constant)
- Measurement Accuracy: ±2.0mm
- Quick Release Push Button Connection

Model No.:

GRZ4-N: Nylon and TPEE Design
GRZ4-M: Metal Design, with QRA01A

GRZ122 360° Prism



GRZ122-N



GRZ122-M QRA01A

- Prism Assembly Consist of Six Mini Prism Glued Together
- Prism Constant: +23.1mm(Swiss Constant)
- Measurement Accuracy: ±2.0mm
- 5/8"-11 Thread at Top for Install Antenna
- Quick Release Push Button Connection

Model No.:

GRZ122-N: Nylon and TPEE Design
GRZ122-M: Metal Design, with QRA01A

MPR122 360° Prism



- Prism Assembly Consist of Six Mini Prisms Glued Together
- With Central Axis for Keeping Stable
- Prism Constant: +28.1mm (Swiss Constant)
- Measurement Accuracy: ±1.0mm
- 5/8"-11 Thread at Top for Install Antenna
- 5/8"-11 Thread at Bottom for Quick Release Adapter
- Quick Release Push Button Connection
- Metal Design

GX360 360° Prism



- Prism Assembly Consist of Six Mini Prisms Glued Together
- Orange Rubber for Falling Protection
- Prism Constant: +23.1mm (Swiss Constant)
- Measurement Accuracy: ±1.5mm
- 5/8"-11 Thread at Top for Install Antenna
- Quick Release Push Button Connection.
- Metal Design

GRZ101S/101 360° Prism



GRZ101S-N GRZ101S-A



GRZ101-N GRZ101-A

- Prism Assembly Consist of Six Mini Prism Glued Together
- Prism Constant: +30 mm (Swiss Constant)
- Aluminum Pole, 1/4"-20 Thread, OD12mm
- 300mm x 4 Sections, Extend to 1.2m (AP123004)
- Pointing Accuracy: ±1.5mm
- Circular Vial 8'

Model No.:

GRZ101S-N: Non-core Axis
GRZ101S-A: With Core Axis
GRZ101-N: Non-core Axis
GRZ101-A: With Core Axis



For option

GRZ4S 360° Prism



- Prism Assembly Consist of Six Mini Prisms Glued Together
- Prism Constant: +23.1mm(Swiss Constant)
- 5/8"-11 Thread at Top for Install Antenna
- Quick Release Push Button Connection
- Metal Design

SE5910-24 360° Sliding Prism



- OD 9mm Solid Steel Pin Poles, Graduated in cm
- Pole Have cm Grooves that the Ball-Detent in the Prism Assembly will Automatically Center On
- Replaceable Stainless Steel Point
- Prism Assembly Consist of Seven OD12.7mm, Silver-Coated Prisms
- Prism Offset: +2mm
- Adjustable Circular vial is 40'

SE6401-00 360° Robotic Prism



- Featuring Six 35mm Prisms
- Copper-coated for Moisture Prevention
- Prism Height: 135mm
- Prism Constant: 0mm
- Protective Urethane Bumper

ATP1 360°Prism



- Featuring Six Accurate Prisms
- Prism Constant: -7mm.
- 5/8" Thread at Top and Bottom

Model No.:

ATP1-P: Nylon and TPEE Frame, without Core Axis

ATP1-M: Metal Frame, with Core Axis, with Adapter

ATP1-MR: Metal Frame, with Core Axis, with Adapter, Anti-collision Ring

ATP2S 360°Prism



- Featuring Six Accurate Prisms
- Prism Constant: -7mm
- 5/8"-11 Thread for Mounting
- 20-inch Long Stainless Steel Pole
- Built-in Circular Bubble Level
- Easy Release-and-Hold Button Mechanism
- Rugged Rubberized Housing

ATP3 360°Prism



- Prism Assembly Features Six 25.4mm Silver-Coating Prisms
- Prism Constant: 0mm
- Metal Frame
- Round Bubble Level

Zero220P 360°Prism



- Built-in Rear Viewport to Check Rear Prism Height Accurately
- Metal Prism Holders
- Prism Offset: 0mm
- Adjustable Round Bubble Level, Circular Vial 40'
- Special Anti-Diffusion Coating

A7 360° Prism



- Prism Constant: +2mm
- Prism Accuracy 3"
- Measurement Accuracy: ± 1.0 mm
- High quality Corner Cube 6 Prisms
- 5/8 inch Adapter
- Mount Platform

R-360MCG 360° Prism



- Replaceable Prisms, Each Prism is Independent and Non-glued
- Metal Frame
- With Core Axis for Keeping Stable
- Seamlessly Connected 6 Prisms Make Strong Beam Reflection
- Prism Constant: -5mm

ST360 Sliding 360° Prism



- Featuring Six Accurate Prisms
- Prism Constant: 0mm
- OD 9mm Stainless Steel Pole
- Built-in Circular Bubble Level
- Metal Design

TR360 360°Prism



- Prism Built in Bubble 20'
- 5/8"-11 Mounting Thread
- Prism Constant: +2mm





















Model No.:



















TR360A

- P/N: 58128001
- Prism Assembly Features Seven 25.4mm Silver-Coating Prisms

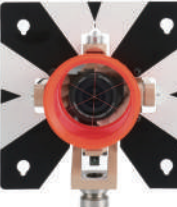
TR360B

- With Mini Prism OD12.7mm
- P/N: 571204312

 <p>C15B-YY Prism Assembly Offset 0/-30mm</p>	 <p>C15B-RR Prism Assembly Offset 0/-30mm</p>	 <p>Z15B-YW Prism Assembly Offset 0/-30mm</p>	 <p>Z15B-YY Prism Assembly Offset 0/-30mm</p>
 <p>Z15B-RW Prism Assembly Offset 0/-30mm</p>	 <p>Z15B-RY Prism Assembly Offset 0/-30mm</p>	 <p>Z15U-YY Prism Assembly Offset 0/-30mm</p>	 <p>Z15U-RO Prism Assembly Offset 0/-30mm</p>
 <p>Z15UB-YY Prism Assembly Offset 0/-30mm</p>	 <p>Z15UB-RO Prism Assembly Offset 0/-30mm</p>	 <p>Z15UB-RR Prism Assembly Offset 0/-30mm</p>	 <p>Z15TB TP Prism Assembly Offset 0mm</p>
 <p>Z15BS-RG SK Prism Assembly Offset 0/-30mm</p>	 <p>Z15BS-RR SK Prism Assembly Offset 0/-30mm</p>	 <p>Z15UD-YB Prism Assembly Offset 0/-30mm</p>	 <p>Z15UD-RR Prism Assembly Offset 0/-30mm</p>
 <p>C34B-YY Triple Prism Assembly Offset 0/-30mm</p>	 <p>C34B-RR Triple Prism Assembly Offset 0/-30mm</p>	 <p>Z34B-YY Triple Prism Assembly Offset 0/-30mm</p>	 <p>Z34B-RY Triple Prism Assembly Offset 0/-30mm</p>

 <p>Z14B-YW Prism Assembly Offset 0/-30mm</p>	 <p>Z14B-YY Prism Assembly Offset 0/-30mm</p>	 <p>Z14U-YY Prism Assembly Offset 0/-30mm</p>	 <p>Z14U-RO Prism Assembly Offset 0/-30mm</p>
 <p>Z14UB-YY Prism Assembly Offset 0/-30mm</p>	 <p>Z14UB-RO Prism Assembly Offset 0/-30mm</p>	 <p>Z14UC-YY Prism Assembly Wide Target Offset 0/-30mm</p>	 <p>Z14UC-YG Prism Assembly Wide Target Offset 0/-30mm</p>
 <p>Z14UE-BY SE Prism Wide Target Offset 0/-30mm</p>	 <p>Z14UE-BR SE Prism Wide Target Offset 0/-30mm</p>	 <p>Z14BS-RG SK Prism Assembly Offset 0/-30mm</p>	 <p>Z14BS-RR SK Prism Assembly Offset 0/-30mm</p>
 <p>Z14TB TP Prism Assembly Offset 0mm</p>	 <p>Z14PT PX Prism Assembly Offset -30mm</p>	 <p>Z14SK-YY SK Prism Assembly Offset 0/-30mm</p>	 <p>Z14SK-RR SK Prism Assembly Offset 0/-30mm</p>
 <p>Z14TRA TR Prism Assembly Offset -35mm</p>	 <p>Z14TRB TR Prism Assembly Offset -35mm</p>	 <p>GPH1P Swiss Prism Assembly Constant 0mm</p>	 <p>GPH1A Swiss Prism Assembly Constant 0mm</p>

GPH1 Swiss Prism Assembly Offset 0mm	GPR111 Swiss Prism Assembly Offset 0mm	GPR121 Swiss Prism Assembly Offset 0mm	GPH3 Swiss Triple Prism Offset 0mm
G254 Prism Glass ϕ 25.4mm	G381 Prism Glass ϕ 38.1mm	G640T Prism Glass ϕ 64.0mm	G640L Prism Glass ϕ 64.0mm
PA127 Corner Prism ϕ 12.7mm	PA254 Prism ϕ 25.4mm	PB254 Prism ϕ 25.4mm	PC254 Prism ϕ 25.4mm
PD254 Prism ϕ 25.4mm	PE254 Prism ϕ 25.4mm	PF254 Prism ϕ 25.4mm	PG254 Prism ϕ 25.4mm
PH254 Prism ϕ 25.4mm	PI254 Prism ϕ 25.4mm	PA381 TP Prism ϕ 38.1mm	PB381 Prism ϕ 38.1mm
PC381 Prism ϕ 38.1mm	PA550 TR Prism ϕ 55.0mm	GPR112 Swiss Prism ϕ 62.0mm	PJ640B Metal Shell Prism ϕ 64.0mm
PA640Y Prism ϕ 64.0mm	PA640R Prism ϕ 64.0mm	PB640Y Prism ϕ 64.0mm	PB640R Prism ϕ 64.0mm
PB640YL Prism with Light ϕ 64.0mm	PB640RL Prism with Light ϕ 64.0mm	PC640R SK Prism ϕ 64.0mm	PD640Y SK Prism ϕ 64.0mm
PE640B Rubber Mat Prism ϕ 64.0mm	PF640R Waterproof Prism ϕ 64.0mm	GPR1 Swiss Prism ϕ 64.0mm	GPR1L Prism with Light ϕ 64.0mm

ST001/ GZT21 Scanning Target



- Black and White Circular Aluminium Target
- Flexible Tilt and Turn for Precise Orientation to the Scanner
- Suit for Swiss-Style Quick Release Adapter

Model No.:

ST001: Circular Planar OD80mm (3.1 in)
GZT21: Circular Planar OD115mm (4.5 in)

ST002 Scanning Target



- Large Size Circular Target with Reflect Sheet
- Flexible Tilt and Turn for Precise Orientation to the Scanner
- Female 5/8"-11 Thread for Mounting on Target Poles or Magnetic Mounts
- Circular Planar OD152mm (6.0 in)

ST003/ ST004 Scanning Target



- Black & White Circular Aluminium Target
- For use with HDS Scanner
- Equipped with Quick Release Adapter

Model No.:

ST003: Circular Target, OD100mm (3.9 in)
ST004: Squared Target, Size: 200 x 200mm

HDS Scanning Target



- Black & White Circular Target
- Flexible Tilt and Turn for Precise Orientation to the Scanner
- Female 5/8"-11 Thread for Mounting on Target Poles or Magnetic Mounts
- Circular Planar OD152mm (6.0 in)

Scanner Spheres



- Precision Design, Allowable Deviation < 1.0mm (Stainless Steel/ Plastic)
- Precision Design, Allowable Deviation < 0.5mm (Carbon Fiber)
- Special Adapter (Female Thread M8) for Mini Prism
- Includes Detachable Magnet Base (M8/20mm(0.8 in))

Model No.:

SS100S: Stainless Steel, OD100mm (3.93 in)
SS200S: Stainless Steel, OD200mm (7.87 in)
SS145P: Plastic (ABS), OD145mm (5.70 in)
SS100C: Carbon Fiber, OD100mm (3.93 in)
SS145C: Carbon Fiber, OD145mm (5.70 in)

Extension Pole



- Male and Female 5/8"-11 Thread
- Height for Option: 10/15/20/25/30/35/40/50/60/80/100cm

Model No. Sample:

EPA25-10: Aluminum, OD25mm, Height 10cm
EPA32-10: Aluminum, OD32mm, Height 10cm
EPC25-10: Carbon Fiber, OD25mm, Height 10cm
EPC32-10: Carbon Fiber, OD32mm, Height 10cm
EPAH32-15/20: Aluminum, with Height Level, OD32mm, Height 15/20cm. Height Lever Pulls Down and Stops at the 90 Degree on Horizontal Position

Magnetic Mount Of Gns Antennas



- Flat Magnetic Mount Allows Setup on Flat Steel Surfaces.
- Male 5/8"-11 Stainless Steel Thread

Model No.:

SMM01: Single Magnetic Mount, OD100mm
TMM01: Triple Magnetic Mount, OD100mm

Scanner Elevator Tripod



- Lightweight and High Durability
- Anti-slip Cover and Exchangeable Rubber Foot
- With 5/8" or 3/8" Adapter
- Head Diameter: 120mm
- Working Height: 700-1400mm

Model No.:

SET-30A: Aluminum Tube
SET-30C: Carbon Fiber Tube

DQY-1 Pocket Compass



- Long Air Level: $15' \pm 3/2\text{mm}$
- Circle Air Level: $30' \pm 8/2\text{mm}$
- Clinometer Reading Error: $\leq 0.5^\circ$
- Dial Scale: 1°

DQL-8 Geology Compass



- Long Air Level: $15' \pm 3/2\text{mm}$
- Circle Air Level: $30' \pm 8/2\text{mm}$
- Clinometer Reading Error: $\leq 0.5^\circ$
- Dial Scale: 1°

DQL-11 Geology Compass



- Long Air Level: $15' \pm 3/2\text{mm}$
- Circle Air Level: $30' \pm 8/2\text{mm}$
- Clinometer Reading Error: $\leq 0.5^\circ$
- Dial Scale: 1°

DQL-16A Height Measurer Compass



- Damping Time (90° Turn Back): ≤ 5 Seconds
- Reading Error: $\leq 0.5^\circ$
- Dial Scale: 1°

DQL-16B Height Measurer Compass



- Damping Time (90° Turn Back): ≤ 5 Seconds
- Reading Error: $\leq 0.5^\circ$
- Dial Scale: 1°

DQL-10A Height Measurer Compass



- Damping Time (90° Turn Back): ≤ 5 Seconds
- Reading Error: $\leq 0.5^\circ$
- Dial Scale: 1°

DQL-16Z Theodolite Compass



- Magnification: 16x Elevation
- Horizontal Dial Scale: 1°
- Horizontal Vernier Scale: 5'
- Vertical Dial Scale: 1°
- Vertical Vernier Scale: 5'
- Stadia Multiplication Constant: 100
- Stadia Additive Constant: 0

CGQ-1 Height Measurer



- Elevation: 60°
- Depression: 30°
- Height Measure Range: 60m Max (Look Up)
20m Max (Look Down)
- Fixed Measure Distance: 15/ 20/ 30/ 40m
- Dial Scale: 0.5m

JG-1 Angle Gauge



- The Angle Pole have Two Kinds of Scale.
- Angle Gauge Constant: $K=1$ $K=2$

DQL-2A Pocket Transit



- Circle Air Level: $30' \pm 5/2\text{mm}$
- Clinometer Reading Error: $\leq 0.5^\circ$
- Dial Scale: 1°

DQL-5 Military Compass



- Measuring Proportion: 1: 50000
1:100000
- Clinometer Reading Error: $\leq 1.25^\circ$
- Dial Scale of Time and Speed: 5min
- Dial Scale: 1°

DQL-7 Military Compass



- Measuring Proportion: 1: 25000
1: 50000
1: 75000
1: 100000
- Clinometer Reading Error: $\leq 1.25^\circ$
- Dial Scale: 1°

DQL100-G1 Compass

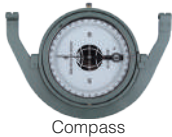

Compass

- Dial Scale: 1°
- Reading Assessment: 30'
- Weight: 0.4Kg(A)
- Size: 242x172x28mm

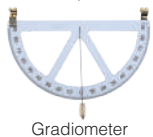

Gradiometer

- Dial Scale: $20'$
- Weight: 0.07Kg(A)
- Size: 200x125x15mm

DQL100-G2 Compass

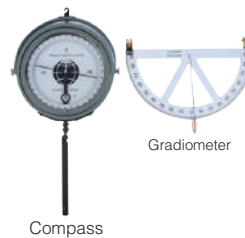

Compass

- Dial Scale: 1°
- Reading Assessment: 30'
- Weight: 0.5Kg(A)
- Size: 320x170x20mm

Gradiometer

- Dial Scale: $20'$
- Weight: 0.07Kg(A)
- Size: 200x125x15mm

SC-1 Digital Gradiometer



- Display Resolution: 0.10°
- Accuracy: $\pm 0.2^\circ$
- Power: 3V CR2032 Battery (Two)

YHJ-50 Laser Gradiometer



- Operating Voltage: DC 3V
- Effective Distance: $< 100m$
- Explosion Protection: Exd I

QCJ-2000 Digital Planimeter



- Measure Range: 300mm Max Width
Unlimited Length
- Relative Error: $\leq \pm 0.2\%$
- Display: LCD with 16 Lattices
- Power: Built-in Battery DC 6V

SHY-150D Scanning Life Leaf Area Measurer



- Scanning Life Leaf Area Measurer
- Relative Error: $\leq \pm 0.2\%$
- Maximum Measuring Area: 1000 x 150mm
- Display: 6 Digits LCD
- Power: Built-in Battery DC 6V

YBJ-800/1200/1500 Laser Orientation Instrument



- Effective Range: 800/1200/1500
- Installation Way: Stationary Type
- Service Voltage: AC 127V
- Way of Explosion Proofing:
- Explosive-proof
- Sign of Explosion Protection: Exd I Mb

CP7 SK Side Mount Tubular Compass



- Used with SK Total Stations and Theodolite
- Allows Setting the Instrument to the Local Magnetic North Direction
- Only Used to Find North and South A Pointer on the South End of the Needle is Viewed Through a Window and Aligned Between Two Index Lines

<p>GFZ3 Diagonal Eyepiece Screw Style for Swiss</p>	<p>GFZ4 Diagonal Eyepiece Bayonet Style for Swiss</p>	<p>DE01 Diagonal Eyepiece for TP GM/ES/OS</p>	<p>DE02 Diagonal Eyepiece for TP GTS/TKS</p>	<p>DE03 Diagonal Eyepiece for SK FX/CX/OS</p>
<p>DE04 Diagonal Eyepiece for GX ZT10</p>	<p>DE05 Diagonal Eyepiece for GX ZT20/30</p>	<p>DE06 Diagonal Eyepiece for NK Total Station</p>	<p>DE07 Diagonal Eyepiece for TR M/C</p>	<p>DE08 Diagonal Eyepiece for TR S</p>
<p>DE09 Diagonal Eyepiece for BH Theodolite</p>	<p>DE10 Diagonal Eyepiece for South NT Theodolite</p>	<p>DE11 Diagonal Eyepiece for South/Sanding/Kolida Theodolite</p>	<p>DE12 Diagonal Eyepiece for South/Sanding/Kolida Total Station</p>	<p>DE13 Diagonal Eyepiece for Ruide Theodolite</p>
<p>DE14 Diagonal Eyepiece for Ruide Total Station</p>	<p>DE15 Diagonal Eyepiece for FOIF Theodolite</p>	<p>DE16 Diagonal Eyepiece for FOIF Total Station</p>	<p>DE17 Diagonal Eyepiece for Hi-Target Total Station</p>	<p>DE18 Diagonal Eyepiece for PX Total Station</p>
<p>CM01 Standard Crack Monitor</p>	<p>CM02 Plus Tell-Tale Crack Monitor</p>	<p>CM03 Standard Tell-Tale Crack Monitor</p>	<p>CM04 Plus Corner Tell-Tale Crack Monitor</p>	<p>CM05 Displacement Tell-Tale Crack Monitor</p>



CW01
Crack Width Gauge



CW02
Crack Width Ruler



LS02
Aluminum Leveling Strip
220x33mm, Division mm



LH01
Stainless Steel Leveling Head
1/2"-12 Thread, H40mm,
OD40mm



BL01
Bubble Level



BL02
PX Total Station
Bubble Level



BL03
Swiss Total Station
Bubble Level

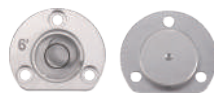

BL04
Swiss NA2 Bubble Level



BL05
Swiss Total Station
Bubble Level



BL06
Swiss Digital Level
Bubble Level



RL01
Plastic Rod Level
Circular Level 40'/2mm



RL02
Aluminum Rod Level
Circular Level 40'/2mm



RL03
Aluminum Rod Level with
Clamp Circular Level 40'/2mm



RL04
Aluminum Rod Level with
Velcro Circular Level 40'/2mm



PA40
Aluminum Rod Level with
Velcro Circular Level 40'/2mm



PC60
Aluminum Rod Level with
Velcro Circular Level 60'/2mm



GLI115
Swiss Plastic Clip-on
Bubble for Mini Reflector Poles



AL01
Abney Hand Level



AL02
Abney Hand Level



AL03
Abney Hand Level
Big Size



HL01
Hand Level
2.5X Magnification



HL02
SE Hand Level
5° Hand Level with 1x
Magnification



HL03
SE Hand Level
2 Power Stadia Hand Level with
a Sharp Field of View and
Stadia Ratio 1:32



HU01
Heads Up Level
Circular Level 40'/2mm
The Bubble is Direct Reading



PB01 Plumb Bob
Model No.:PB01-08/10/12/14/
16/18/24/32/36
Weight: 8/10/12/14/16/18/24/32/36OZ

<p>L RTP01 Leveling Rod Turning Plate 3Kg</p>	<p>L RTP02 Leveling Rod Turning Plate 5Kg</p>	<p>TS02 Prism Pole Topo Shoe HT85.6mm, 5/8"-11 Thread</p>	<p>TS01 Prism Pole Wide Base Topo Shoe HT85.6mm, 5/8"-11 Thread</p>	<p>CPP01 Center Punch Point Fit Product with 5/8" Thread The Hardened Steel Point will Mark on Metal and Non Metal Surfaces</p>
<p>MF01 Marking Flags PVC Material</p>	<p>FT01 Flagging Tape PVC Material Thickness: 0.05/0.127mm Length: 30/45/100m</p>	<p>SM01 Surveying Marker SM01-BU: Blue Color SM01-RD: Red Color SM01-YE: Yellow Color</p>	<p>SN01 Steel Surveying Nail SN01-755: OD7mm x 55mm SN01-770: OD7mm x 70mm</p>	<p>PS01 Pocket Stereoscope Adjustable: 56-75mm Magnification: 4X</p>
<p>HC-AL01 Hard Case for Auto Level General Use Single Lock</p>	<p>HC-AL02 Hard Case for Auto Level General Use Double Lock</p>	<p>HC-TH01 Hard Case for Theodolite General Use</p>	<p>HC-TS01 Hard Case for Total Station General Use</p>	<p>HC-TS02 Hard Case for NK Total Station</p>
<p>HC-TS03 Hard Case for TP GTS102/332 Total Station</p>	<p>HC-TS04 Hard Case for TP GM/ES/GTS200 Total Station</p>	<p>HC-TS06 Hard Case for Swiss TS02/06/09</p>	<p>HC-TS07 Hard Case for Swiss TS03/07 TZ05/07/08/12</p>	<p>HC-TS15 Hard Case for Swiss TS15/16</p>
<p>HC-TM30 Hard Case for Swiss TM30/50</p>	<p>HC-PS01 Hard Case for Prism Set Single Design</p>	<p>HC-PS02 Hard Case for Prism Set Double Design</p>	<p>HC-PS03 Hard Case for Prism Set Double Design</p>	<p>HC-GN01 Hard Case for GNSS</p>

SC-MP01 Soft Case for L Bar Mini Prism	SC-MP02 Soft Case for MP061 Mini Prism	SC-MP03 Soft Case for SP066 Mini Prism	SC-TA01 Soft Case for Tribrach and Adapter Round Design	SC-TA02 Soft Case for Tribrach and Adapter Square Design
SC-PA01 Soft Case for C14/15B Prism Assembly	SC-PA02 Soft Case for Z14/15U Prism Assembly	SC-PA03 Soft Case for Z14/15BS Prism Assembly	SC-PA04 Soft Case for Z14/15TB Prism Assembly	SC-PA05 Soft Case for Prism Assembly with Sponge
SC-PA06 Soft Case for Prism Big Plate with Sponge	SC-PS01 Soft Case for Prism Set General Quality	SC-PS02 Soft Case for Prism Set Better Quality	SC-GN01 Soft Case for GNSS	SC-GN02 Soft Case for GNSS
SC-GN03 Soft Case for TR GNSS Antenna	SC-GN04 Soft Case for TR GNSS	SC-MR01 Soft Case with Rigid Frame for TR Modular Receiver	SC-DC01 Soft Case for TR Data Collector	SC-SC01 Soft Case for Spray Can
SC-TS01 Soft Case for Swiss Total Station	SC-TS02 Soft Case for Swiss Total Station	SC-TS03 Soft Case for Swiss Total Station	SC-TD01/02 Soft Case for Tripod Length: 90/120cm	SC-GP02 Soft Case for GPS Pole



MRS01S
Magnetic Rail Shoe
5/8"-11 Thread



MRS01L
Magnetic Rail Shoe
Swiss Stub Mount



RC01
Stainless Steel Rail Clamp
For Railway Monitoring



RC02
Stainless Steel Rail Clamp
For Railway Monitoring



SMB01/02
Switchable Magnetic Mount
SMB01: 5/8"-11 Adapter
SMB02: Swiss Spigot



CP01
Aluminum Column Plate
5/8"-11 Thread
OD: 135mm



CP02
Stainless Steel Column Plate
5/8"-11 Thread
OD: 150mm



PRC01
Prism Rain Cover
Stainless Steel
(Not include Plate and Prism)



GSZ4
Swiss Height Hook



Cable/Battery/Charger
For Total Station,
Theodolite, GPS, GNSS
Compatible with Different Brand



SU01
Surveying Umbrella
• Diameter: 200cm
• Height: 200cm
• Weight: 3.5kg

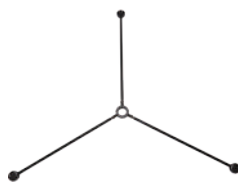

TSFG01
Tripod Stabilizer Floor Guide
• Spray Paint Steel Legs
• Collapses to 40cm
• One 4mm Holes in Each Leg



TSFG02
Tripod Stabilizer Floor Guide
• Anodized Aluminum Legs
• Collapses to 60cm
• Three 8mm Holes in Each Leg, At 36/47/58cm
• O-rings to Hold Tripod Foot in Place



TD01
Tripod Dolly
• Ball Bearing Casters with Cable Guards
• Adjustable Velcro Straps to keep Tripod Secure



HDCC01
Heavy-Duty Column Clamp
• The Adjustable Column Rotates and Moves Vertically to Orient the Instrument
• Use for All 5/8"-11 Instrument
• Heavy Duty Ratchet to Create a Strong Connection to Both Round and Square Columns



IWB01
Steel Instrument Wall Bracket
• A Solidly Designed Monitoring System of Steel Wall Plates and Demountable Tables for Surveying within Tunnels
• Centring is Better than 0.25mm.
• Back Plate: 10kg, 380 x 254 x 10mm. Table: 9kg, 535 x 254 x 10mm



IWB02
Instrument Wall Bracket
• A Solid Designed Wall Bracket made from 50mm Angled Steel
• A Square 200 x 200 x 10mm Plate is Supplied with a Fixed (non-rotatable) 5/8" screw
• Mounting is Carried Out using Four Heavy Duty M10 Anchor Bolts
• Four Plating Pieces are Welded on the Back Side of the Wall Attachments to Guarantee Highly Reliable Positioning, Three Distances from the Wall are Available



IWB03
Light Weight Instrument Wall Bracket
• Very Light and Easy to Transport Bracket of High Manufacturing Quality for all Modern Surveying Instruments
• Since a Number of Instrument Positions are Seldom Used Simultaneously, the System is Extremely Economical Because Only a Single Wall Bolt is Installed for Every Position
• Weight: 2.3kg



IWB04
Stainless Steel Instrument Wall Bracket
• The Assembly and Horizontal Adjustment is Done in Less than a Minute
• The Clamping Mechanism Allows Use of Even the Heaviest of Instruments with a Load in Excess of 80kg
• A Rotatable and Tilttable Hinged Arm and Instrument Plate Means the Instruments Can be Fixed into Almost Every Position
• Length: 540mm



IWB05
Stainless Steel Instrument Wall Bracket
• More Flexible than the IWB04 as There are no Joints Necessary for Mounting, Can be Bolted Directly to the Wall
• Mounting is Possible at Any Position and on Almost All Surfaces
• The Non Obstructive Sunken Wall Plug Can Remain in the Wall Even if not in Use
• Load in Excess of 80kg
• Length: 590mm

DZ Aluminum Mini Prism Pole



- Mini Prism Pole
- OD25mm
- 30' Circular Vial
- Style A: Short Tip
- Style B: Long Tip
- Adapter for Option

Model No :

DZ02A: Length 10cm, Add Prism HT 20cm DZ02B: Length 14cm, Add Prism HT 24cm
 DZ03A: Length 20cm, Add Prism HT 30cm DZ03B: Length 20cm, Add Prism HT 30cm
 DZ04A: Length 30cm, Add Prism HT 40cm DZ04B: Length 30cm, Add Prism HT 40cm
 DZ05A: Length 40cm, Add Prism HT 50cm DZ05B: Length 40cm, Add Prism HT 50cm

Swiss Style Snap Lock Prism Pole



- Telescopic Aluminum Pole with Snap Lock
- 2 Sections, Extend to 2.15m
- Adapter for Option

Model No :

DZ215SL-RW: White and Red
 DZ215SL-SR: Silver
 GLS11: With Swiss Adapter, M/Ft Dual Scale
 GLS12: With Swiss Adapter
 GLS13: With 5/8"-11 Adapter

DZ215SL-RW DZ215SL-SR GLS11 GLS12 GLS13

GN Aluminum Economic Knob Lock Prism Pole



- Economic Style Prism Pole
- Knob Lock System
- 30' Circular Vial

Model No :

GN210KL: 2.10m, 2S OD25/30mm
 GN310KL: 3.10m, 3S OD18/25/30mm
 GN510KL: 5.10m, 4S OD18/25/30/36mm
 GN800KL: 8.00m, 6S OD8/24/29/35/41/48mm

GN210 GN310 GN510

DZ Aluminum Prism Pole

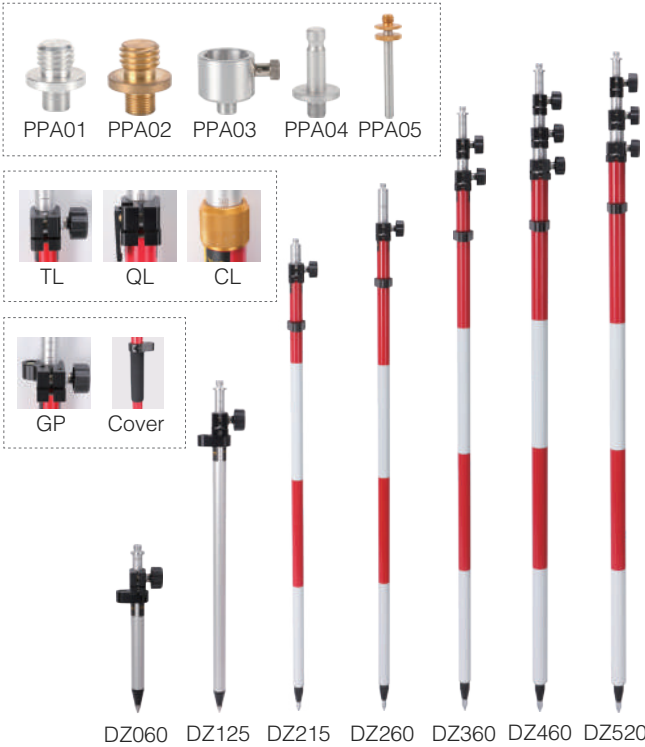

- High Quality Style Prism Pole
- 30' Circular Vial
- Lock System for Option
 - TL: Twist Lock
 - QL: Quick Release Lock
 - CL: Compression Lock
 - GP: GPS Style Lock
- Adapter for Option
- Rubber Anti-Skid Cover for Option

Model No :

- DZ060TL/QL: 0.60m, 2S, OD18/25mm
- DZ125TL/QL: 1.25m, 2S, OD18/25mm
- DZ215TL/QL/GP: 2.15m, 2S, OD25/30mm
- DZ260TL/QL/CL/GP: 2.60m, 2S, OD25/30mm
- DZ360TL/QL/CL/GP: 3.60m, 3S, OD18/25/30mm
- DZ460TL/QL/CL/GP: 4.60m, 4S, OD18/25/30/36mm
- DZ520TL/QL/GP: 5.20m, 4S, OD18/25/30/36mm

CLS Aluminum Prism Pole



- Handheld Mini Prism Pole Easy to Set Up
- 30' Circular Vial

Model No :

- CLS012: 120mm, OD32mm, 5/8"-11 Thread
- CLS013: 114mm, OD32mm, Swiss-style Quick Release Adapter
- CLS039: 390mm, OD32mm, 5/8"-11 Thread
- CLS155: 1.55m, OD18/25/32mm, Adjustable Adapter

CLS Fiberglass Prism Pole



- Fiberglass Tube
- Nylon Twist Lock System
- 30' Circular Vial
- Adjustable Adapter

Model No :

- CLS260FG: 2.60m, 2 Sections, OD25/32mm
- CLS360FG: 3.60m, 3 Sections, OD19/25/32mm
- CLS460FG: 4.60m, 4 Sections, OD19/25/32/38mm

GPS Pole 2.00 Meter 2 Sections



GP200-2A Black Aluminum
GP200-2A Green Aluminum
GP200-2C Black Carbon Fiber

- Extend to 2.00 Meter, 2 Sections
- 30' Circular Vial
- OD32mm
- E: Economic Style

Model No :

- **GP200-2A**
GPS Pole, Aluminum, Black and Green Color for Option
- **GP200-2C**
GPS Pole, Carbon Fiber, Black Color
- **EGP200-2C**
Economic Style GPS Pole, Carbon Fiber, Black Color

GPS Pole 4/ 6 Sections



GP200-4A Yellow Aluminum
GP200-4C Black Carbon Fiber

- Extend to 1.80 Meter, 4 Sections
- Extend to 2.00 Meter, 4 Sections
- Extend to 3.00 Meter, 6 Sections
- C: Carbon Fiber
- A: Aluminum, Yellow or Black Option
- 30' Circular Vial
- OD32mm
- E: Economic Style

Model No :



GP180/ 200-4C
GP180-4A
GP180-4C
EGP180-4C
GPS Pole, 1.80m



GP300-6C
GP300-6A
GP300-6C
EGP300-6C
GPS Pole, 3.00m

GP200-4A
GP200-4C
EGP200-4C
GPS Pole, 2.00m

GPS Pole with Compression Lock



GP150CL-4A GP180CL-3A

- 30' Circular Vial
- E: Economic Style
- **GP150CL-4A**
GP180CL-3A
GPS Pole, 1.50m/ 1.80m Compression Lock 4/ 3 Sections Aluminum
- **GP150CL-4C**
GP180CL-3C
GPS Pole, 1.50m/ 1.80m Compression Lock 4/ 3 Sections Carbon Fiber
- **EGP150CL-4C**
EGP180CL-3C
Economic GPS Pole, 1.50m/ 1.80m Compression Lock 4/ 3 Sections Carbon Fiber

GPS Pole with Quick Release (Snap) Lock



GP180SQ-3C GP210QL-AC

GP180SQ-3C:

- GPS Pole, Carbon Fiber
- Extended to 1.80 Meter
- Equipped with Snap and Quick Release Lock
- OD25/30/32mm

GP210QL-AC:

- GPS Pole, Inner/ Outer Tube Aluminum/ Carbon Fiber
- Extended to 2.10 Meter
- Equipped with Quick Release Lock
- OD25/32mm

GPS Pole with Twist Lock



GP250TL-AA GP250TL-AC GP250TL-CC GP250TLD-AC GP250TLD-CC GP360TLD-CC GP460TLD-CC



- Equipped with Twis tLock
- 30' Circular Vial
- E: Economic Style
- **GP220TL-AA**
GP250TL-AA
GPS Pole 2.20/ 2.50m
Inner/ Outer Tube Aluminum
- **(E)GP220TL-AC**
(E)GP250TL-AC
GPS Pole 2.20/ 2.50m
Inner/ Outer Tube Aluminum/ Carbon Fiber
- **GP250TLD-AC**
GPS Pole 2.50m
Inner/ Outer Tube Aluminum/ Carbon Fiber
Inner Tube Black Anodized
Dual Scale(D) (m/ ft)
Outer Pole have Scale(S)
- **(E)GP220TL-CC**
(E)GP250TL-CC
GPS Pole 2.20/ 2.50m
Inner/ Outer Tube Carbon Fiber
- **GP250TLD-CC**
GP360TLD-CC
GP460TLD-CC
GPS Pole 2.50/ 3.60/ 4.60m
Inner/ Outer Tube Carbon Fiber
Dual Scale(D) (m/ ft)

GPS Pole with Snap and Compression Lock



GP180SC-AA

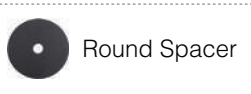

Round Spacer

- Extend to 1.80m, 2 Sections
- Equipped with Snap and Compression Lock
- Inner/ Outer Tube: Aluminum OD18/25mm
- With 5/8"-11 Copper Adapter for GPS Antenna
- Round Spacer for Option

Model No.:

- **GP180SC-AA**
GPS Pole 1.80m, Inner/ Outer Tube Aluminum



GP200SC-AA GP200SC-CC

- Extended to 2.00m, 2 Sections
- Equipped with Snap and Compression Lock
- OD25/32mm
- 30' Circular Vial
- One-piece Design and Two Locking System for Stability
- Snap Lock Guarantees no Slipping
- Compression Lock Centers the Telescoping Inner and Maintains Straightness
- Snap Lock at 1.60m/ 1.80m/ 2.00m

Model No.:

- **GP200SC-AA:**
GPS Pole 2.00m, Inner/ Outer Tube Aluminum
- **GP200SC-CC:**
GPS Pole 2.00m, Inner/ Outer Tube Carbon Fiber

				
TC-1 Open Clamp Bracket Diameter 20-38mm Pole	TC-1-1 Open Clamp Bracket Diameter 20-40mm Pole	TC-2 Open Clamp Bracket Diameter 20-38mm Pole with Compass	TC-2E Open Clamp Bracket Diameter 20-38mm Pole with Compass	TC-3 Open Clamp Bracket Diameter 32mm or 1/4 inch Pole with Bubble and Compass
				
TC-4 Quick Release Clamp Diameter 32mm or 1/4 inch Pole with Compass	TC-4E Quick Release Clamp Diameter 32mm or 1/4 inch Pole with Compass, Economic Style	TC-4-Q Quick Release Clamp with 1" Ram Ball Diameter 32mm or 1/4 inch Pole with Compass	TC-4-2 Quick Release Clamp Diameter 32mm or 1/4 inch Pole with Bubble	TC-5 Quick Release Clamp Diameter 32mm or 1/4 inch Pole
				
TC-5-Q Quick Release Clamp with 1" Ram Ball Diameter 32mm or 1/4 inch Pole	T65 Ball and Socket Link Fits the 1" Ram Ball on Pole Clamp and Cradle	TC-6 Adjustable Holder Recon, Archer, Getac535 Width: 92-72mm Height: 30mm	TC-6E Adjustable Holder Recon, Archer, Getac535 Width: 92-72mm Height: 30mm	TC-7 Adjustable Holder CEO, CE, XT, XM, TSCE Width: 95-75mm Height: 47mm
				
TC-10 Adjustable Holder Geo 6000 Width: 110-95mm Height: 47mm	TC-9 Plate for Convert Holder Convert CS10, CS15 Holder for SE Connect Mode	TF-3 Claw Type Holder South H5	TC-8-24 Claw Type Holder CHC HCE600 Efix FC2	TC-8 Claw Type Holder TSC2, Ranger 300X and 500X, Hi-Target 30
				
TC-8-1 Claw Type Holder Archer, Swiss DX10, Carlson Mini, Javad Victor, 536, Qmini, 30(HT)	TC-8-2 Claw Type Holder FC-500	TC-8-3 Claw Type Holder FC-100, FC200, FC250 Mobile Mapper CE and CX, GIS(HT)	TC-8-3E Claw Type Holder Hi-Target iHand 55/30	TC-8-3Q Claw Type Holder FC-100, FC200, FC250 Mobile Mapper CE and CX, GIS(HT)

				
TC-8-4 Claw Type Holder Allegro MX and CX, Explorer, Tracker, FC-2200	TC-8-5 Claw Type Holder Recon	TC-8-6 Claw Type Holder TSC3/ Ranger3	TC-8-7 Claw Type Holder Geo 6000	TC-8-9 Claw Type Holder Carlson Surveyor
				
TC-8-9E Claw Type Holder CHC HCE300, HCE320	TC-8-10 Claw Type Holder Nomad 800 Series	TC-8-11 Claw Type Holder CHC LT30, TP FC-50	TC-8-12 Claw Type Holder JUNO5T series/ SP T41 SLATE	TC-8-13 Claw Type Holder JUNO3, Q/R
				
TC-8-14 Claw Type Holder Allegro 2, Surveyor 2	TC-8-15 Claw Type Holder Archer 2	TC-8-17M Claw Type Holder Nautiz X8	TC-8-19 Claw Type Holder Unistrong P9	TC-8-21 Claw Type Holder Ranger 7
				
TC-8-22 Claw Type Holder TSC7	TC-8-23 Heavy Duty Tablet Holder FC5000/ MESA2/ MESA3/ RT3/ RT4/ Tesla	TC-8-29 Claw Type Holder TSC5/ Ranger 5	T57 Heavy Duty Tablet Holder For 8/10" Tablet	T67 Heavy Duty Tablet Holder Panasonic FZ-M1/B2, QR
				
T68 Heavy Duty Tablet Holder Panasonic FZ-G1	T72S/L X-grip Holder T72S: 5-6" Tablet T72L: 6-7.5" Tablet	T80S/L Adjustable Holder T80S: 5.5-9.5cm T80L: 11.5-14cm	T81 Adjustable Holder For Smart Phone 5.8-10cm	T82 Adjustable Holder For Smart Phone and Tablet 7.5-15cm

RP Range Pole



- Range Pole 1 Meter 1 Section
- Available 2m, 3m, 5m with Carry Bag

Model No.:

RP-A22: Aluminum, Extended to 2m, 2 Sections
 RP-A33: Aluminum, Extended to 3m, 3 Sections
 RP-A55: Aluminum, Extended to 5m, 5 Sections

RP-S22: Strong Steel, Extended to 2m, 2 Sections
 RP-S33: Strong Steel, Extended to 3m, 3 Sections
 RP-S55: Strong Steel, Extended to 5m, 5 Sections

RP-CA Range Pole

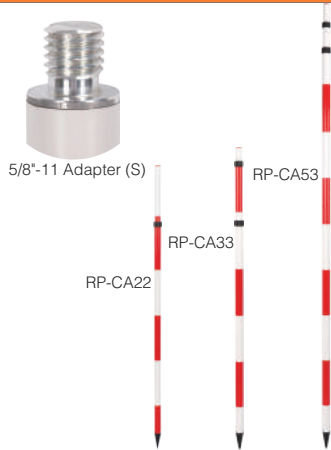

- Telescopic Precision Aluminum Tube with Compression Lock
- Available 2m, 3m, 5m with Carry Bag

For Option

5/8"-11 Adapter on the Top (S)

Model No.:

RP-CA22: Extended to 2m, 2 Sections
 RP-CA33: Extended to 3m, 3 Sections
 RP-CA53: Extended to 5m, 3 Sections
 RP-CA22S: Extended to 2m, 2 Sections, with 5/8"-11 Adapter
 RP-CA33S: Extended to 3m, 3 Sections, with 5/8"-11 Adapter
 RP-CA53S: Extended to 5m, 3 Sections, with 5/8"-11 Adapter

RP-IS Range Pole



- Insert Type Strong Steel Tube
- 50cm Red and White Banded Color Spray-paint
- 1m for 1 Section

Model No.:

RP-IS11: Extended to 1m, 1 Section
 RP-IS22: Extended to 2m, 2 Sections
 RP-IS33: Extended to 3m, 3 Sections

PP-200D2 Prism Pole

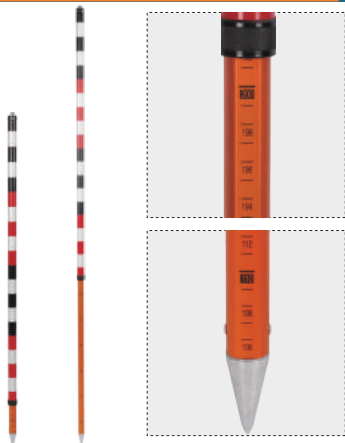

- Lower Extension Type with Compression Lock System
- 5/8"-11 Screw on the Top
- Un-rusted Stainless Shoe Catch Ground Steadily
- Inverse Scale Reading

Chaining Pin

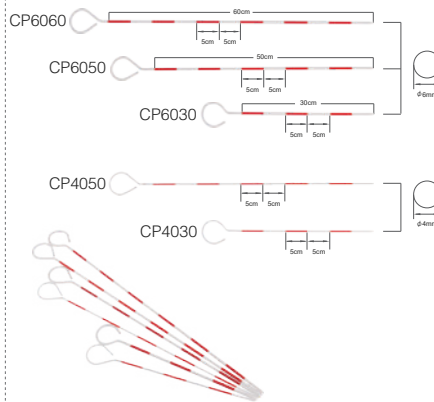

- Chaining Pin with Alternating Red and White Color
- Made of Spring Steel
- Various Size for Option

Model No.:

CP4030: Diameter 4.0mm, Length: 30cm
 CP4050: Diameter 4.0mm, Length: 50cm
 CP6030: Diameter 6.0mm, Length: 30cm
 CP6050: Diameter 6.0mm, Length: 50cm
 CP6060: Diameter 6.0mm, Length: 60cm
 CP80100: Diameter 8.0mm, Length: 100cm

Pin Pole

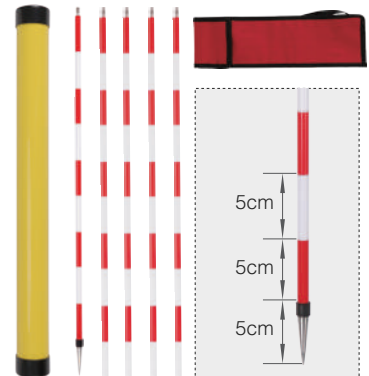

- Stainless Steel Material
- Pin Pole with Red and White
- OD 9mm
- M6 Thread
- With Removable Tip
- Packed with Aluminum Tube (T) or Soft Bag (S)

Model No.:

SP093005: 300mm x 5 Sections, Extend to 1.5m
 SP095003: 500mm x 3 Sections, Extend to 1.5m
 SP096001: 600mm x 1 Section, Extend to 0.6m
 SP096003: 600mm x 3 Sections, Extend to 1.8m
 SP0910001: 1000mm x 1 Section, Extend to 1.0m
 SP0915001: 1500mm x 1 Section, Extend to 1.5m

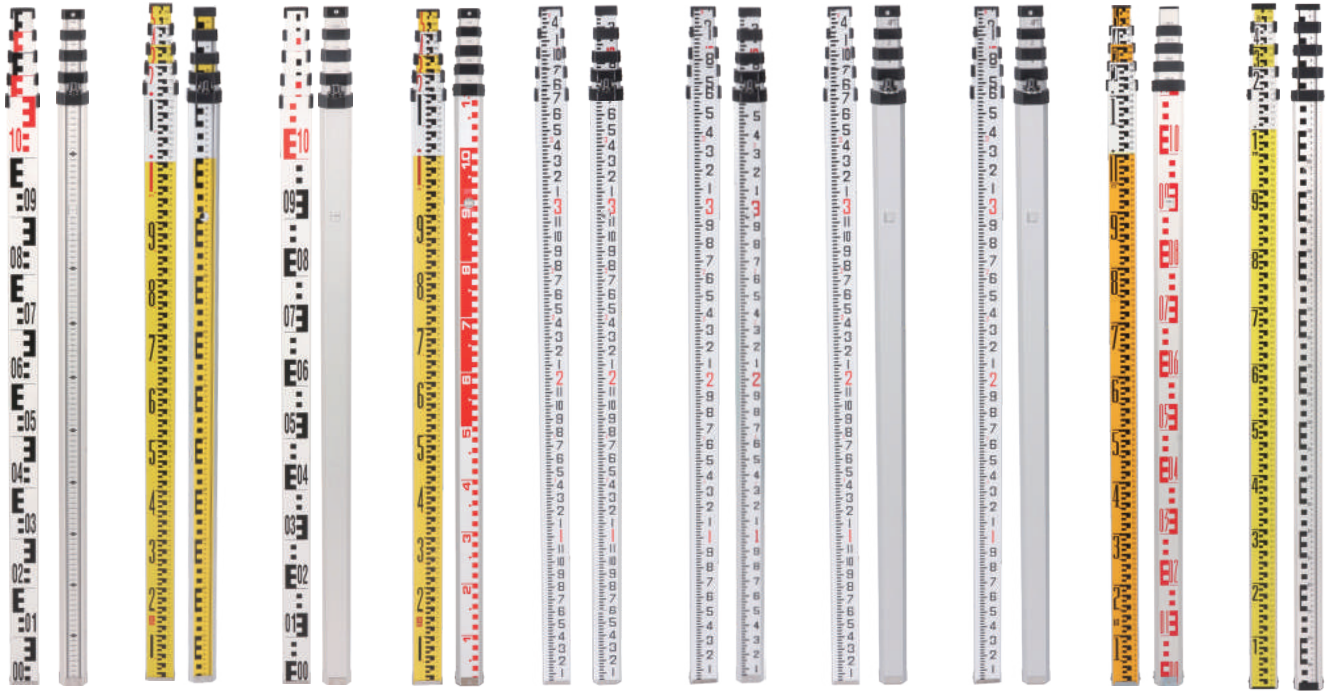

L1S1 L2S2 L3S3 L4S4 L5S5 (8th) L6S6 (10th) L7S7 (8th) L8S8 (10th) L9S9 L10S10

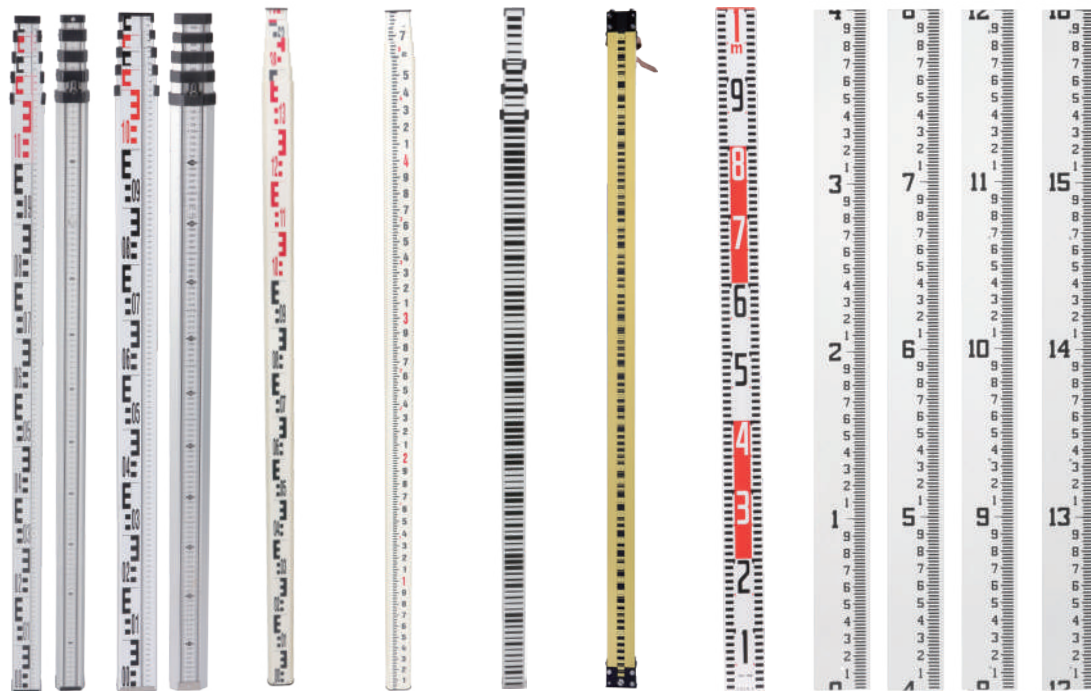

L11S11 L12S12 (Width: 72mm) Fiberglass Staff (M) Fiberglass Staff (Ft) Barcode Staff Invar Staff Cross Rod Steam Gauge

Steam Gauge

- Instantly Observe Water Levels
- Fiberglass Material Assures a Long Life; It does not Rot, Rust, or Corrode
- Provided in Separate Units that can be Used Separately or Combined for Convenient Measuring
- Available in 1m or 4 Feet

TPS-PS Triangle Prism Support



- **TPS:** Triangle Prism Support Only
- **PSSL:** Prism Pole, Stainless Steel, with Stainless Steel Swiss Adapter
- **PSCL:** Prism Pole, Stainless Steel, with Copper Swiss Adapter
- **PSSS:** Prism Pole, Stainless Steel, with Stainless Steel 5/8"-11 Adapter
- **PSCS:** Prism Pole, Stainless Steel, with Copper 5/8"-11 Adapter
- **TPS-PSSL:** Prism Support with Pole, with Stainless Steel Swiss Adapter
- **TPS-PSCL:** Prism Support with Pole, with Copper Swiss Adapter
- **TPS-PSSS:** Prism Support with Pole, with Stainless Steel 5/8"-11 Adapter
- **TPS-PSCS:** Prism Support with Pole, with Copper 5/8"-11 Adapter

TPS02 Triangle Prism Support



- With Two Long Vials
- With Two Adjustable Foot Screw for Easy Leveling

Model No.:

- **TPS02-AL:** Triangle Prism Support with Aluminum Swiss Adapter
- **TPS02-AS:** Triangle Prism Support with Aluminum 5/8"-11 Adapter

MNB01/ MNT01 Aluminum Mini Bipod/ Tripod



- Material: Silver Oxide Aluminum
- Suit for Mini Prism Pole
- Height: 220mm

MNB02/ MNT02 Aluminum Mini Bipod/ Tripod

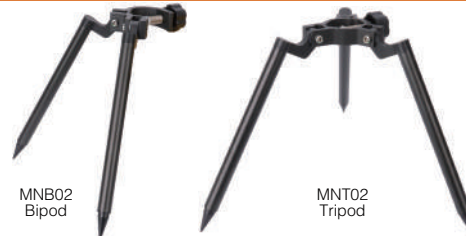

- Material: Polished Black Oxide Aluminum
- Suit for Mini Prism Pole
- Height: 290mm

CPPS Compact Aluminum Pole Tripod



- For DM Pole and Prism Pole
- Extended: 600mm, Closed: 459mm, OD18/25mm
- Legs Holding by Telescopic Legs Stopper, Compression Lock
- Free Movable Scissors Type Head
- Aluminum Inner and Outer Tube

PPS Aluminum Pole Tripod



- For DM Pole and Prism Pole
- Extended: 1200mm, Closed: 760mm, OD18/25mm
- Legs Holding by Telescopic Legs Stopper, Compression Lock
- Free Movable Scissors Type Head
- Aluminum Inner and Outer Tube

MPPS Aluminum Pole Tripod



- For DM Pole and Prism Pole
- Extended: 900mm, Closed: 620m, OD18/25mm
- Legs Holding by Telescopic Legs Stopper, Compression Lock
- Free Movable Scissors Type Head
- Aluminum Inner and Outer Tube
- Head Part Slides 80mm
- Easy to Adjust Pole Location by Sliding Scissors Grip

FPPSII Aluminum Pole Tripod



- For DM Pole and Prism Pole
- Extended: 1280mm, Closed: 810m, OD18/25mm
- Legs Holding by Telescopic Legs Stopper, Compression Lock
- Free Movable Scissors Type Head
- Aluminum Inner and Outer Tube
- Head Part Slides 80mm
- Head Shape: Holder for Φ 25-30mm or Φ 8-10mm Pole
- Easy Holding by One-touch Grip

DZ22A Aluminum Bipod



- Thumb Release Bipod for Pole, Leveling Staff, Invar Staff
- Extended: 1800mm, Closed: 1090mm, OD18/25mm
- Inner Tube: Oxidized Aluminum, Silver Color
- Outer Tube: Oxidized Aluminum
- Fixed Foot and Removable Tip

DZ33A Aluminum Tripod



- Thumb Release Tripod for Pole
- Extended: 1800mm, Closed: 1090mm, OD18/25mm
- Inner Tube: Oxidized Aluminum, Silver Color
- Outer Tube: Oxidized Aluminum
- Fixed Foot and Removable Tip

CLS22A Aluminum Bipod



- Thumb Release Bipod for Pole, Leveling Staff, Invar Staff
- Extended: 1800mm, Closed: 1090mm, OD18/25mm
- Inner Tube: Polished Oxidized Aluminum, Black Color
- Outer Tube: Polished Oxidized Aluminum
- Removable Foot and Removable Tip

CLS33A Aluminum Tripod



- Thumb Release Tripod for Pole
- Extended: 1800mm, Closed: 1090mm, OD18/25mm
- Inner Tube: Polished Oxidized Aluminum, Black Color
- Outer Tube: Polished Oxidized Aluminum
- Removable Foot and Removable Tip

CLS22C Carbon Fiber Bipod



- Thumb Release Bipod for Pole, Leveling Staff, Invar Staff
- Extended: 1800mm, Closed: 1090mm, OD18/25mm
- Inner Tube: Polished Oxidized Aluminum, Black Color
- Outer Tube: Carbon Fiber
- Removable Foot and Removable Tip

CLS33C Carbon Fiber Tripod



- Thumb Release Tripod for Pole
- Extended: 1800mm, Closed: 1090mm, OD18/25mm
- Inner Tube: Polished Oxidized Aluminum, Black Color
- Outer Tube: Carbon Fiber
- Removable Foot and Removable Tip

QPPS Aluminum Prism Tripod



- For DM Pole and Prism Pole
- Extended: 1200mm, Closed: 760mm, OD18/25mm
- Legs Holding by Quick Release Clamp
- Free Movable Scissors Type Head
- Aluminum Inner and Outer Tube

CSR2 Aluminum Bipod



- For DZ215SL and CLS11 Prism Pole
- Material Oxidized Aluminum
- Telescopic Legs with Snap Lock

ERJA10 Economic Round Leg J Series Aluminum 10 Style Tripod

Economic Lightwave Tripod



Flat Head

1) ERJA10-FAT:

Flat Head OD126mm, Twist Lock, 960-1600mm, 2.20Kg

2) ERJA10-FAD:

Flat Head OD126mm, Dual Lock, 960-1500mm, 2.70Kg



Dome Head

1) ERJA10-DAT:

Dome Head OD126mm, Twist Lock, 960-1600mm, 2.20Kg

2) ERJA10-DAD:

Dome Head OD126mm, Dual Lock, 960-1500mm, 2.70Kg



Big Round Head

1) ERJA10-BAT:

Big Round Head OD133mm, Twist Lock, 960-1600mm, 2.30Kg

2) ERJA10-BAD:

Big Round Head OD133mm, Dual Lock, 960-1500mm, 2.80Kg

RJA10 Round Leg J Series Aluminum 10 Style Tripod

Lightwave Tripod



Flat Head

1) RJA10-FAT:

Flat Head OD126mm, Twist Lock, 960-1600mm, 2.70Kg

2) RJA10-FAD:

Flat Head OD126mm, Dual Lock, 960-1500mm, 3.30Kg



Dome Head

1) RJA10-DAT:

Dome Head OD126mm, Twist Lock, 960-1600mm, 2.70Kg

2) RJA10-DAD:

Dome Head OD126mm, Dual Lock, 960-1500mm, 3.30Kg



Big Round Head

1) RJA10-BAT:

Big Round Head OD133mm, Twist Lock, 960-1600mm, 2.80Kg

2) RJA10-BAD:

Big Round Head OD133mm, Dual Lock, 960-1500mm, 3.40Kg

RJA20 Round Leg J Series Aluminum 20 Style Tripod

Medium Duty Tripod
Self-Locking System for Option (S)



Self-Locking (S)
For Option



Flat Head

1) RJA20-FAT(S):

Flat Head OD160mm, Twist Lock, 1010-1700mm, 3.70Kg

2) RJA20-FAD(S):

Flat Head OD160mm, Dual Lock, 1010-1600mm, 4.30Kg



Dome Head

1) RJA20-DAT(S):

Dome Head OD160mm, Twist Lock, 1010-1700mm, 3.70Kg

2) RJA20-DAD(S):

Dome Head OD160mm, Dual Lock, 1010-1600mm, 4.30Kg



Big Round Head

1) RJA20-BAT(S):

Big Round Head OD165mm, Twist Lock, 1010-1700mm, 3.80Kg

2) RJA20-BAD(S):

Big Round Head OD165mm, Dual Lock, 1010-1600mm, 4.40Kg

SJA30 Square Leg J Series Aluminum 30 Style Tripod

Heavy Duty Tripod



Flat Head

1) SJA30-FCT:

Flat Head OD160mm, Copper Center Screw, Twist Lock, 1040-1690, 4.00Kg

2) SJA30-FCD:

Flat Head OD160mm, Copper Center Screw, Dual Lock, 1040-1610mm, 4.55Kg

RTA10 Round Leg T Series Aluminum 10 Style Tripod

Lightwave High Quality Tripod
Self-Locking System for Option (S)



Flat Head

1) RTA10-FCT(S) :

Flat Head OD140mm, Copper Center Screw, Twist Lock, 1010-1700mm, 3.10Kg

1) RTA10-FCD(S) :

Flat Head OD140mm, Copper Center Screw, Dual Lock, 1010-1700mm, 3.70Kg

RTA20(G) Round Leg T Series Aluminum 20 Style Tripod

Medium Duty High Quality Tripod
Self-Locking System for Option (S)



Flat Head

1) RTA20(G)-FCT(S):

Flat Head OD160mm, Copper Center Screw, Twist Lock, 1040-1730mm, 3.80Kg

2) RTA20(G)-FCD(S):

Flat Head OD160mm, Copper Center Screw, Dual Lock, 1040-1670mm, 4.40Kg



Dome Head

1) RTA20(G)-DCT(S):

Dome Head OD160mm, Copper Center Screw, Twist Lock, 1040-1730mm, 3.80Kg

2) RTA20(G)-DCD(S):

Dome Head OD160mm, Copper Center Screw, Dual Lock, 1040-1670mm, 4.40Kg



Big Round Head

1) RTA20(G)-BCT(S):

Big Round Head OD165mm, Copper Center Screw, Twist Lock, 1040-1730mm, 3.90Kg

2) RTA20(G)-BCD(S):

Big Round Head OD165mm, Copper Center Screw, Dual Lock, 1040-1670mm, 4.50Kg

STA30 Square Leg T Series Aluminum 30 Style Tripod

Heavy Duty High Quality Tripod
Self-Locking System for Option (S)



Flat Head

1) STA30-FCT(S):

Flat Head OD160mm, Copper Center Screw, Twist Lock, 1050-1740mm, 4.80Kg

2) STA30-FCD(S):

Flat Head OD160mm, Copper Center Screw, Dual Lock, 1050-1680mm, 5.40Kg



Dome Head

1) STA30-DCT(S):

Dome Head OD160mm, Copper Center Screw, Twist Lock, 1050-1740mm, 4.80Kg

2) STA30-DCD(S):

Dome Head OD160mm, Copper Center Screw, Dual Lock, 1050-1680mm, 5.40Kg



Big Round Head

1) STA30-BCT(S):

Big Round Head OD165mm, Copper Center Screw, Twist Lock, 1050-1740mm, 4.90Kg

2) STA30-BCD(S):

Big Round Head OD165mm, Copper Center Screw, Dual Lock, 1050-1680mm, 5.50Kg

GST103 Swiss Original Aluminum Tripod

Original Style



Flat Head

1) GST103-FCT:

Flat Head OD160mm, Copper Center Screw, Twist Lock, 1030-1660mm, 4.40Kg

2) GST103-FCD:

Flat Head OD160mm, Copper Center Screw, Dual Lock, 1030-1600mm, 5.00Kg

RTW20A/B Round Leg T Series Wooden 20 Style Tripod

Heavy Duty Wooden Tripod

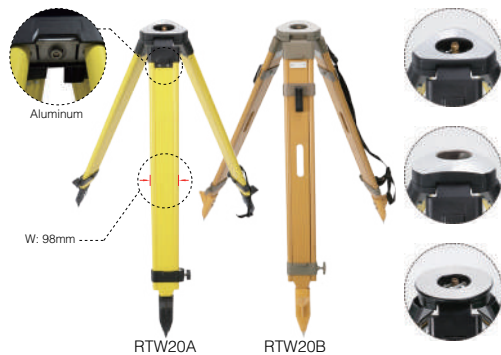

Flat Head

1) RTW20A/B-FCT:

Flat Head OD160mm, Copper Center Screw, Twist Lock, 1060-1725mm, 6.00Kg

2) RTW20A/B-FCD:

Flat Head OD160mm, Copper Center Screw, Dual Lock, 1060-1675mm, 6.70Kg

Dome Head

1) RTW20A/B-DCT:

Dome Head OD160mm, Twist Lock, 1080-1750mm, 6.10Kg

2) RTW20A/B-DCD:

Dome Head OD160mm, Dual Lock, 1080-1660mm, 6.80Kg

Big Round Head

1) RTW20A/B-BCT:

Big Round Head OD165mm, Copper Center Screw, Twist Lock, 1060-1725mm, 6.30Kg

2) RTW20A/B-BCD:

Big Round Head OD165mm, Copper Center Screw, Dual Lock, 1060-1675mm, 7.00Kg

RTW30 Round Leg T Series Wooden 30 Style Tripod

Heavy Duty High Quality Wooden Tripod.



Flat Head

1) RTW30-FCT:

Flat Head OD160mm, Copper Center Screw, Twist Lock, 1190-1900mm, 6.90Kg

2) RTW30-FCD:

Flat Head OD160mm, Copper Center Screw, Dual Lock, 1190-1850mm, 7.60Kg

Big Round Head

1) RTW30-BCT:

Big Round Head OD165mm, Copper Center Screw, Twist Lock, 1190-1900mm, 7.20Kg

2) RTW30-BCD:

Big Round Head OD165mm, Copper Center Screw, Dual Lock, 1190-1850mm, 7.90Kg

GST20-9/120-9 Swiss Wooden Tripod

Heavy Duty High Quality Wooden Tripod.

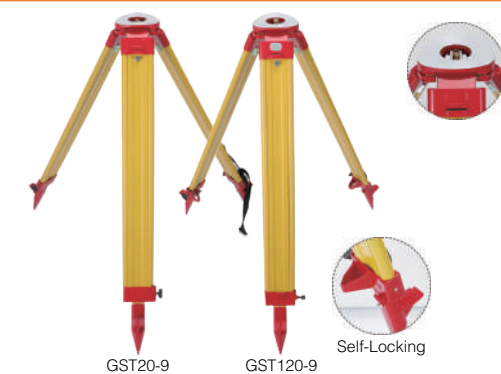

Flat Head

1) GST20-9-FCT:

Flat Head OD160mm, Copper Center Screw, Twist Lock, 1090-1810mm, 5.90Kg

2) GST120-9-FCT:

Flat Head OD160mm, Copper Center Screw, Twist Lock, 1090-1810mm, 5.95Kg with Self-Locking

DW-1/ C-TS2 TP/ PX Original Wooden Tripod

Original Style



Flat Head

1) DW-1-FCT:

Flat Head OD160mm, Copper Center Screw, Twist Lock, 1100-1760mm, 6.95Kg

2) DW-1-FCD:

Flat Head OD160mm, Copper Center Screw, Dual Lock, 1100-1735mm, 7.60Kg

Flat Head

1) C-TS2-FCT:

Flat Head OD160mm, Copper Center Screw, Twist Lock, 1100-1760mm, 6.95Kg

2) C-TS2-FCD:

Flat Head OD160mm, Copper Center Screw, Dual Lock, 1100-1735mm, 7.60Kg

RTF20 Round Leg T Series Fiberglass 20 Style Tripod

Heavy Duty Fiberglass Tripod



Flat Head

1) RTF20-FCT:

Flat Head OD160mm, Copper Center Screw, Twist Lock, 1070-1725mm, 5.00Kg

2) RTF20-FCD:

Flat Head OD160mm, Copper Center Screw, Dual Lock, 1070-1650mm, 5.60Kg



Big Round Head

1) RTF20-BCT:

Big Round Head OD165mm, Copper Center Screw, Twist Lock, 1070-1725mm, 5.15Kg

2) RTF20-BCD:

Big Round Head OD165mm, Copper Center Screw, Dual Lock, 1070-1650mm, 5.85Kg

RTF30A Round Leg T Series Fiberglass 30A Style Tripod

Heavy Duty High Quality Fiberglass Tripod



Flat Head

1) RTF30A-FCT:

Flat Head OD160mm, Copper Center Screw Twist Lock, 1113-1830mm, 7.00Kg

2) RTF30A-FCD:

Flat Head OD160mm, Copper Center Screw Dual Lock, 1113-1780mm, 7.70Kg



Big Round Head

1) RTF30A-BCT:

Big Round Head OD165mm, Copper Center Screw, Twist Lock, 1113-1830mm, 7.20Kg

2) RTF30A-BCD:

Big Round Head OD165mm, Copper Center Screw, Dual Lock, 1113-1780mm, 7.90Kg

RTF30B Round Leg T Series Fiberglass 30B Style Tripod

Heavy Duty High Quality Fiberglass Tripod



Big Round Head

1) RTF30B-BCT:

Big Round Head OD165mm, Copper Center Screw, Twist Lock, 1170-1900mm, 7.80Kg

2) RTF30B-BCD:

Big Round Head OD165mm, Copper Center Screw, Dual Lock, 1170-1850mm, 8.55Kg

RTF30C Round Leg T Series Fiberglass 30C Style Tripod

Tri-max Heavy Duty High Quality Fiberglass Tripod



Big Round Head

1) RTF30CA-BCT:

Big Round Head OD165mm, Copper Center Screw, Twist Lock, 1170-1900mm, 7.00Kg

2) RTF30CA-BCD:

Big Round Head OD165mm, Copper Center Screw, Dual Lock, 1170-1850mm, 8.60Kg

Nylon Quick Lock and Feet

Big Round Head

1) RTF30CB-BCT:

Big Round Head OD165mm, Copper Center Screw, Twist Lock, 1170-1900mm, 8.00Kg

2) RTF30CB-BCD:

Big Round Head OD165mm, Copper Center Screw, Dual Lock, 1170-1850mm, 9.60Kg

Aluminum Quick Lock and Feet

1 Series Economic Laser Level Tripod



YS1150H

BS1150



Removable
1/4"-20 Thread

Economic Style

- Standard 5/8"-11 Thread
- Height: 0.45/1.20/1.50m
- YS1: Yellow (Y), Steel (S), Spray-paint
- BS1: Black (B), Steel (S), Spray-paint
- S1: Silver (S), Non-oxide Aluminum
- OS1: Oxide Aluminum(O), Silver (S)
- OB1: Oxide Aluminum(O), Black (B)
- Horseshoe Style Foot (H)



S/OS1150



US1150HP

Head Style



P: Plastic



R: Removable
Tilting

Model No. Sample:

- YS1150: Yellow (Y), Steel (S), 1.50m
 BS1150: Black (B), Steel (S), 1.50m
 S1150: Silver (S), Non-oxide Aluminum, 1.50m
 OS1150: Oxide Aluminum(O), Silver (S), 1.50m
 OB1150: Oxide Aluminum(O), Black (B), 1.50m

Upgraded Version Style (U)

- Plastic Head 5/8"-11 Thread (P)
- Height: 0.45/1.20/1.50m
- Aluminum Oxide
- Silver Color (S)/ Black Color (B)
- Horseshoe Style Foot (H)
- Removable Tilting Head with Removable 1/4"-20 Thread (R) for Option

Model No. Sample:

- US1150HP: Silver Color 1.50m, Plastic Head 5/8"-11 Thread
 US1150HPR: Silver Color 1.50m, Keep Plastic Head, Add a Removable Tilting Head
 UB1150HP: Black Color 1.50m, Plastic Head 5/8"-11 Thread
 UB1150HPR: Black Color 1.50m, Keep Plastic Head, Add a Removable Tilting Head

S2 Series Silver Laser Level Tripod



S2150HP

Head Style



P: Plastic



A: Aluminum



B: Big Round



R: Removable
Tilting

For Option



Handle



Hook

High Quality Style

- Silver Color (S)
- Horseshoe Style Foot (H)
- Standard Head: Plastic Head 5/8"-11 Thread (P)
- Oxide Aluminum Tube

For Option

- Handle
- Hook

Head for Option

- Aluminum Head 5/8"-11 Thread (A)
- Big Round Galvanized Head 5/8"-11 Thread (B)
- Removable Tilting Head with Removable 1/4"-20 Thread (R)

Head for Option

1.20/1.50/1.80m (Other Height Customized)

Model No. Sample:

- S2150HP: 1.50m, Plastic Head 5/8"-11 Thread
 S2150HA: 1.50m, Aluminum Head 5/8"-11 Thread
 S2150HB: 1.50m, Big Round Head 5/8"-11 Thread
 S2150HPR: 1.50m, Keep Plastic Head, Add a Removable Tilting Head with Removable 1/4"-20 Thread

S11/B11 Series Mini Style Silver Laser Level Tripod



S11050

For Option



LLA01

Mini Style

- High Quality Style
- Silver Color (S11)
- Black Color (B11)
- Standard Head: Fixed Tilting Head with Removable 1/4"-20 Thread (F)
- Oxide Aluminum Tube

Head for Option

0.50/1.00m (Other Height Customized)

Model No. :

- S11050F: Silver Color, 0.50m, Fixed Tilting Head with Removable 1/4"-20 Thread
 B11050F: Black Color, 0.50m, Fixed Tilting Head with Removable 1/4"-20 Thread
 S11100F: Silver Color, 1.00m, Fixed Tilting Head with Removable 1/4"-20 Thread
 B11100F: Black Color, 1.00m, Fixed Tilting Head with Removable 1/4"-20 Thread

BS5/B5 Series Black Laser Level Tripod



B5120HF

For Option



LLA01

Removable 1/4"-20 Thread



Laser Level Tripod

- Black Color (B)
- Horseshoe Style Foot (H)
- Standard Head: Fixed Tilting Head with Removable 1/4"-20 Thread (F)

Height for Option

1.20/1.50/1.70m (Other Height Customized)

BS5 Series Steel Tube (S)

Model No. :

- BS5120HF: 1.20m, Fixed Tilting Head with Removable 1/4"-20 Thread
- BS5150HF: 1.50m, Fixed Tilting Head with Removable 1/4"-20 Thread
- BS5170HF: 1.70m, Fixed Tilting Head with Removable 1/4"-20 Thread

B5 Series Aluminum Tube

Model No. :

- B5120HF: 1.20m, Fixed Tilting Head with Removable 1/4"-20 Thread
- B5150HF: 1.50m, Fixed Tilting Head with Removable 1/4"-20 Thread
- B5170HF: 1.70m, Fixed Tilting Head with Removable 1/4"-20 Thread

B3 Series Black Laser Level Tripod

High Quality (Hexagonal Tube)



B3160HP

Head Style

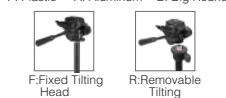

For Option



Hook
Cover



Removable
1/4"-20 Thread

High Quality (Hexagonal Tube)

- Black Color (B)
- Horseshoe Style Foot (H)
- With Handle
- Standard Head: Plastic Head 5/8"-11 Thread (P)
- 3 Sections Design
- Oxide Aluminum Tube

For Option

- Hook
- Rubber Anti-Skid Cover

Head for Option

- Aluminum Head 5/8"-11 Thread (A)
- Big Round Galvanized Head 5/8"-11 Thread (B)
- Fixed Tilting Head with Removable 1/4"-20 Thread (F)
- Removable Tilting Head with Removable 1/4"-20 Thread (R)

Height for Option

1.20/ 1.60/ 1.80/ 3.00m (Other Height Customized)

Model No. Sample:

- B3160HP: 1.60m, Plastic Head 5/8"-11 Thread
- B3160HA: 1.60m, Aluminum Head 5/8"-11 Thread
- B3160HB: 1.60m, Big Round Head 5/8"-11 Thread
- B3160HF: 1.60m, Fixed Tilting Head with Removable 1/4"-20 Thread
- B3160HPR: 1.60m, Keep Plastic Head, Add a Removable Tilting Head with Removable 1/4"-20 Thread

B4 Series Black Laser Level Tripod

High Quality (Quadrilateral Tube)



B4160HB

Head Style

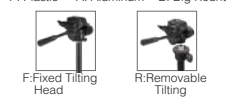

For Option



Hook
Cover



Removable
1/4"-20 Thread

High Quality (Quadrilateral Tube)

- Black Color (B)
- Horseshoe Style Foot (H)
- With Handle
- Standard Head: Plastic Head 5/8"-11 Thread (P)
- 3 Sections Design
- Oxide Aluminum Tube

For Option

- Hook
- Rubber Anti-Skid Cover

Head for Option

- Aluminum Head 5/8"-11 Thread (A)
- Big Round Galvanized Head 5/8"-11 Thread (B)
- Fixed Tilting Head with Removable 1/4"-20 Thread (F)
- Removable Tilting Head with Removable 1/4"-20 Thread (R)

Height for Option

1.20/ 1.60/ 2.00m (Other Height Customized)

Model No. Sample:

- B4160HP: 1.60m, Plastic Head 5/8"-11 Thread
- B4160HA: 1.60m, Aluminum Head 5/8"-11 Thread
- B4160HB: 1.60m, Big Round Head 5/8"-11 Thread
- B4160HF: 1.60m, Fixed Tilting Head with Removable 1/4"-20 Thread
- B4160HPR: 1.60m, Keep Plastic Head, Add a Removable Tilting Head with Removable 1/4"-20 Thread

<p>ETT20A1-180/ ETT20A2-180</p>  <ul style="list-style-type: none"> • Full Closed: 660mm • Full Extended: 1920mm • Elevating Range: 380mm • Working Height: 850-1800mm <p>Model No. :</p> <ul style="list-style-type: none"> • ETT20A1-180: 1.45kg (3 sections, Medium Size) • ETT20A2-180: 1.60kg (3 sections, Big Size) 	<p>ETT20A2-220/ ETT20A3-220</p>  <p>ETT20A2-220 (3 Sections)</p> <p>ETT20A3-220 (4 Sections)</p> <ul style="list-style-type: none"> • Full Closed: 850/ 720mm • Full Extended: 2360/ 2400mm • Elevating Range: 380mm • Working Height: 790-2300/ 690-2300mm <p>Model No. :</p> <ul style="list-style-type: none"> • ETT20A2-220: 1.90kg (3 sections, Big Size) • ETT20A3-220: 1.90kg (4 sections) 	<p>ETT20A3-300</p>  <ul style="list-style-type: none"> • Full Closed: 90mm • Full Extended: 3100mm • Elevating Range: 380mm • Working Height: 850-3000mm <p>Model No. :</p> <ul style="list-style-type: none"> • ETT20A3-300: 2.30kg (4 sections)
<p>ETJ30-240</p>  <ul style="list-style-type: none"> • Full Closed: 1090mm • Full Extended: 2400mm • Elevating Range: 700mm • Working Height : 1000-2230mm • Weight: 4.95kg 	<p>ETJ30-300</p>  <ul style="list-style-type: none"> • Full Closed: 1150mm • Full Extended: 3240mm • Elevating Range: Inner/Outer 780/700mm • Working Height : 1040-3050mm • Weight: 5.25kg 	<p>ETJ30-350</p>  <ul style="list-style-type: none"> • Full Closed: 1250mm • Full Extended: 3440mm • Elevating Range: Inner/Outer 780/700mm • Working Height : 1120-3240mm • Weight: 5.45kg
<p>ETT30-170</p>  <ul style="list-style-type: none"> • Full Closed: 730mm • Full Extended: 1700mm • Elevating Range: Inner/ Outer 410/ 420mm • Working Height : 660-1600mm • Weight: 5.40kg 	<p>ETT30-240/300/350</p>  <ul style="list-style-type: none"> • Full Closed: 990/ 1230/ 1330mm • Full Extended: 2440/ 3000/ 3500mm • Working Height : 900-2300mm(240) • Working Height : 1100-2700mm(300) • Working Height : 1200-3300mm(350) • Weight: 6.10/ 6.50/ 7.50kg 	<p>ETT30-400S</p>  <ul style="list-style-type: none"> • Full Closed: 1650mm • Full Extended: 4150mm • Elevating Range: Inner/ Outer 730/ 760mm • Working Height : 1570-4000mm • Weight: 8.60kg